

Valmet – unique offering with process technology, automation and services

Roadshow presentation
November 2022

Agenda

Valmet roadshow presentation

1 Valmet in brief

2 Investment highlights

3 Financials

4 Summary



Valmet in brief

We have strong market shares and unique offering

Process technologies



Board and Paper

Market position
#1



Pulp and Energy

Market position
#1-3

Services



Market position
#1-2

Automation



Flow Control

Market position in Pulp and Paper
#1

Strong positions in

- Control valves and demanding on/off valves
- Process industry segments including pulp and paper



Automation Systems

Market position in Pulp and Paper
#1-3

Niche positions in other process industry segments

Valmet's development since 2013

Orders received
(EUR billion)

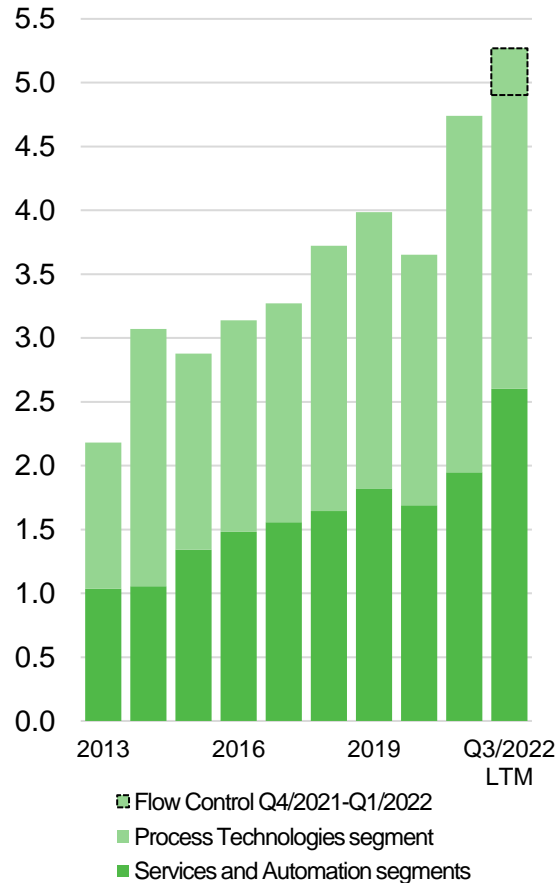

Net sales
(EUR billion)

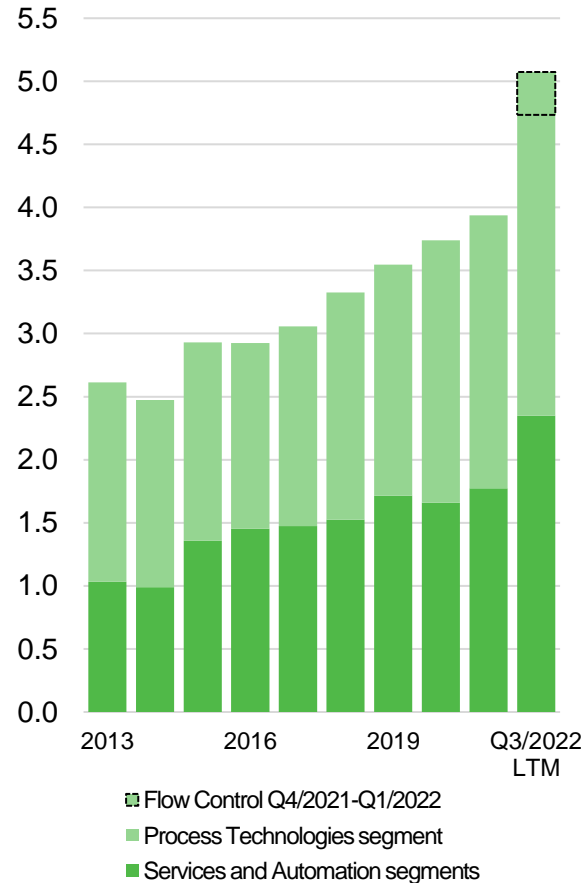

Comparable EBITA
(EUR million)

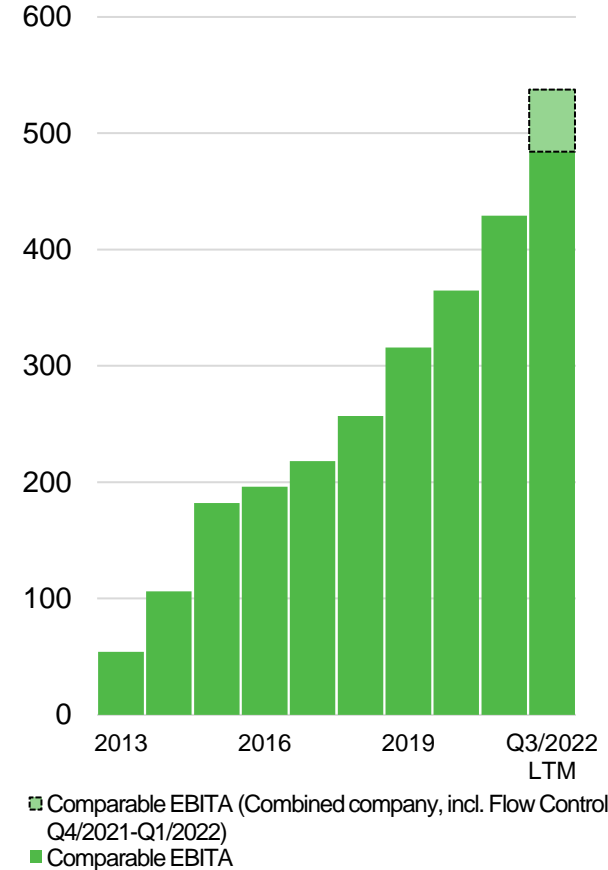

Comparable EBITA margin
(%)

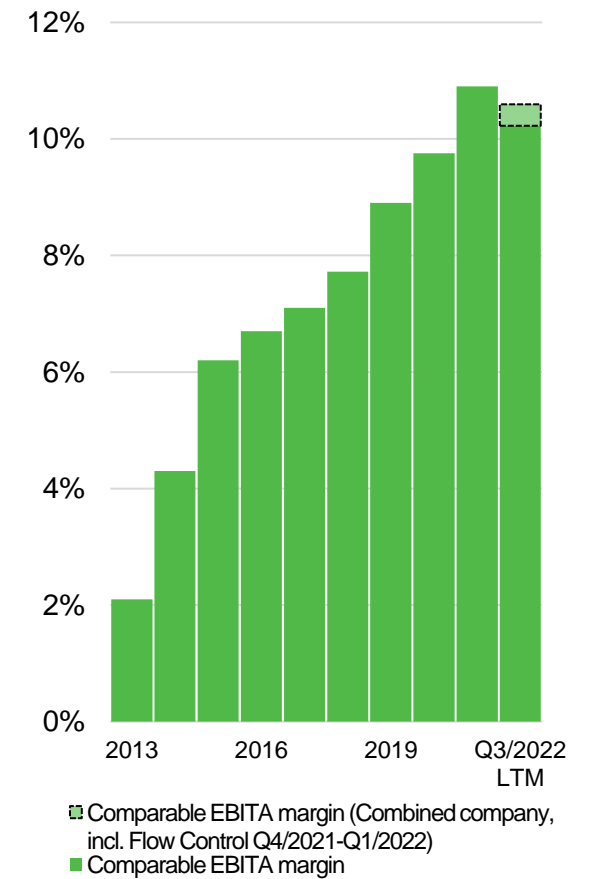

Figures for Flow Control Q4/2021–Q1/2022 and combined company are illustrative. Source for Flow Control Q4/2021–Q1/2022 figures: Neles' financial statements 2021 and interim report Q1/2022. 2013 figures on carve-out basis. 2013–2020 figures have not been restated.

Valmet has three strong segments

Illustrative key figures for LTM Q3/2022

Orders received
EUR 5,268 million

Net sales
EUR 5,073 million

Comparable EBITA
EUR 537 million

Comparable EBITA margin
10.6%

Order backlog
EUR 4,672 million

Employees
17,511

Net sales by segment

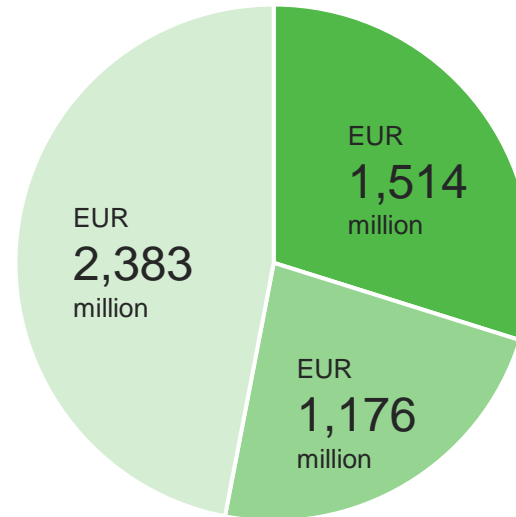

- Services
- Automation
- Process Technologies

Comparable EBITA by segment

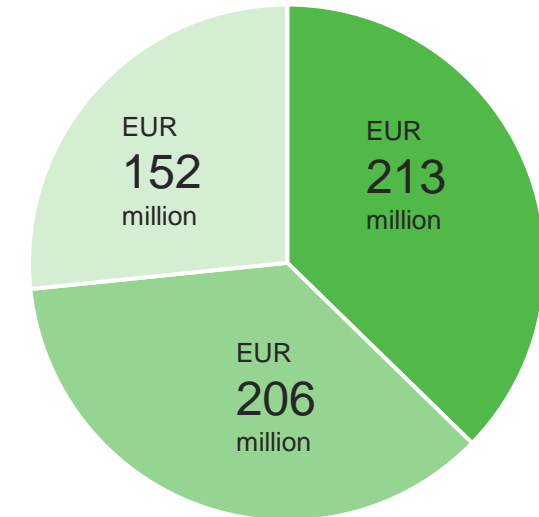

- Services
- Automation
- Process Technologies

Illustrative figures of the combined company.

Global presence creating a good platform for growth in Services and Automation

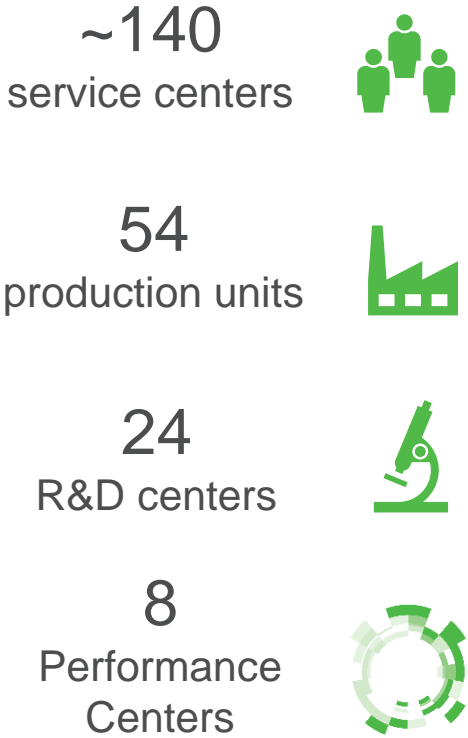
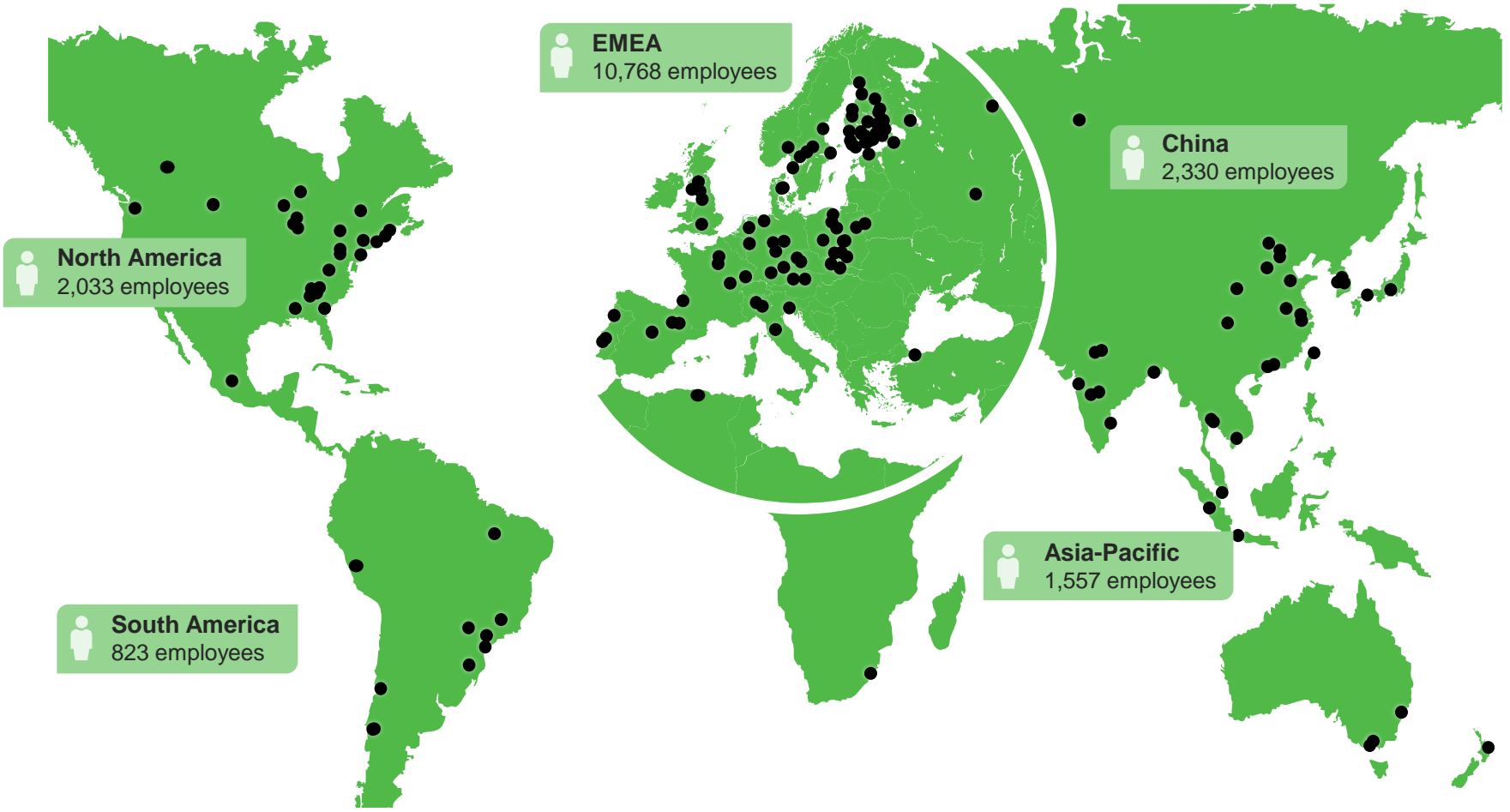

Personnel as at September 30, 2022.



Valmet's Way Forward

Mission

Converting renewable resources into sustainable results

Strategy

Valmet develops and supplies competitive and reliable process technologies, services and automation to the pulp, paper and energy industries.

Our automation business covers a wide base of global process industries.

We are committed to moving our customers' performance forward with our unique offering and way to serve.

Continuous improvement and renewal

Must-Wins

- Customer excellence
- Leader in technology and innovation
- Excellence in processes
- Winning team

Business accelerators

Vision

To become the global champion in serving our customers and in moving the industries forward

Our Values



Customers

We move our customers' performance forward



Renewal

We promote new ideas to create the future



Excellence

We improve every day to deliver results



People

We work together to make a difference

Megatrends

- Resource efficient and clean world
- Digitalization and new technologies
- Urban, responsible and global consumer

Valmet's R&D is aiming to address global megatrends

R&D focus areas

- Promotion of renewable materials
- Raw material, water and energy efficiency
- Emission reductions
- Circularity
- Productivity and environmental improvements with digitalization

24

research and
development centers



EUR **98** million
R&D spending
in 2021



~1,300
protected
inventions

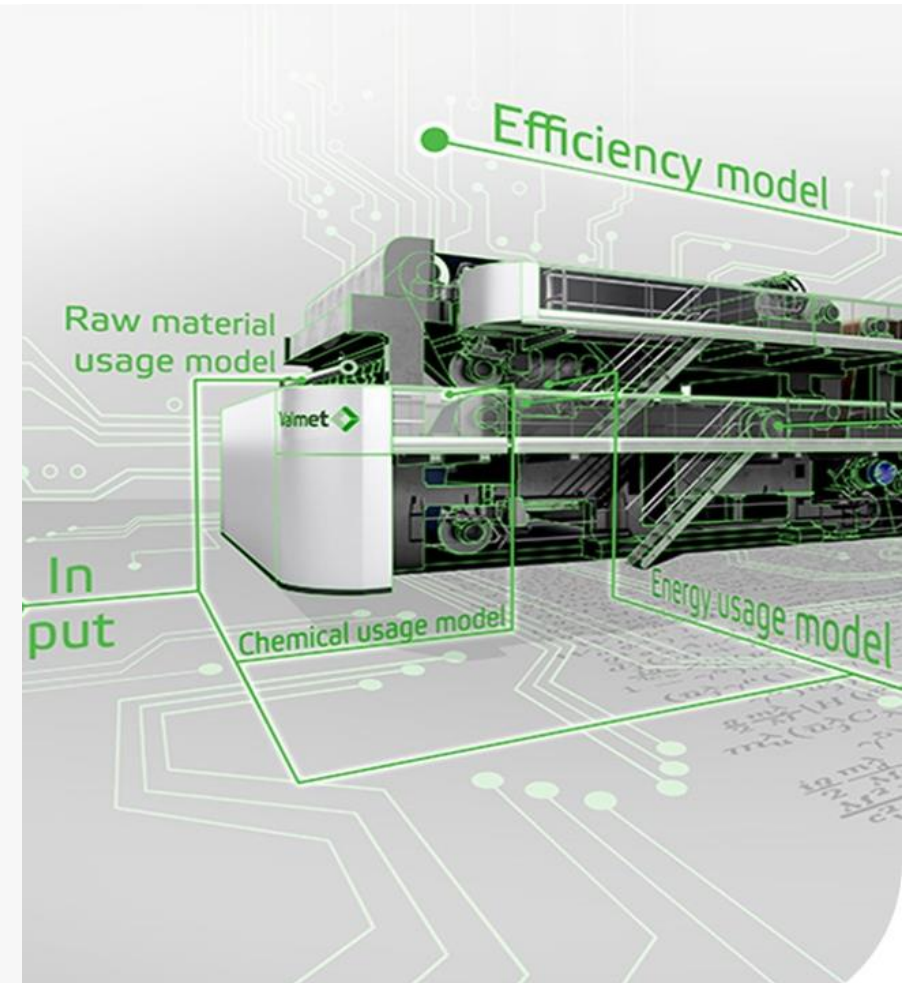

Illustrative figures of the combined company.

Acknowledged leader in sustainability

360° approach to sustainability across value chain

Good sustainability ratings

- In Dow Jones Sustainability Index for the eighth consecutive year
- AAA rating in the MSCI ESG Ratings assessment 2022
- Bronze Class 2022 Sustainability Award
- Achieved B rating in CDP's climate program ranking 2021



Member of
**Dow Jones
Sustainability Indices**
Powered by the S&P Global CSA



**Sustainability Award
Bronze Class 2022**
S&P Global



**MSCI
ESG RATINGS**
AAA



Valmet's Climate Program: Forward to a carbon neutral future

Targets by 2030 for the entire value chain

SUPPLY CHAIN

-20%

CO₂ emission reduction

OWN OPERATIONS

-80%

CO₂ emission reduction

USE PHASE OF VALMET'S TECHNOLOGIES

-20%

Further reduced energy use
of Valmet's current technologies

100%

Carbon neutral production

- Valmet's new Climate Program sets credible targets and concrete actions for 2030 for the entire value chain
- Program is aligned with the Paris Climate Agreement's 1.5-degree pathway and UN Sustainable Development Goals and approved by the Science Based Targets Initiative (SBTi)

Main actions to reach targets by 2030

- Target CO₂ emission reductions from supply chain
- Reduce energy usage and use renewable fuels and CO₂ free electricity and district heating in own locations
- Improve energy efficiency of our existing process technology offering by 20%
- Develop existing and new technologies to enable carbon neutral production for our customers

Financial targets

Growth

Net sales for Services and Automation segments to grow over two times the market growth

Net sales for Process Technologies segment to exceed market growth

Profitability

Comparable EBITA:
12–14%

ROCE

Comparable return on capital employed (ROCE) before taxes¹ at least 15%

Dividend policy

Dividend payout at least 50% of net profit

¹: Comparable ROCE before taxes = (profit before taxes + interests and other financial expenses +/- items affecting comparability) / (balance sheet total - non-interest-bearing liabilities (average for the period))



Investment highlights

Investment highlights

- 1 Strong position in the growing market of converting renewables
- 2 Unique offering combining process technology, services and automation
- 3 EUR 3.0 billion recurring and steadily growing stable business
- 4 Services: The widest offering and strong geographical presence
- 5 Flow Control: Strong and diversified offering across many process industries
- 6 Automation Systems: Maximizing efficiency and safety of our customers
- 7 Paper: World-class technology for packaging and hygiene needs
- 8 Pulp and Energy: Strong business with high market share and flexible cost structure
- 9 Systematically building the future with continuous improvement

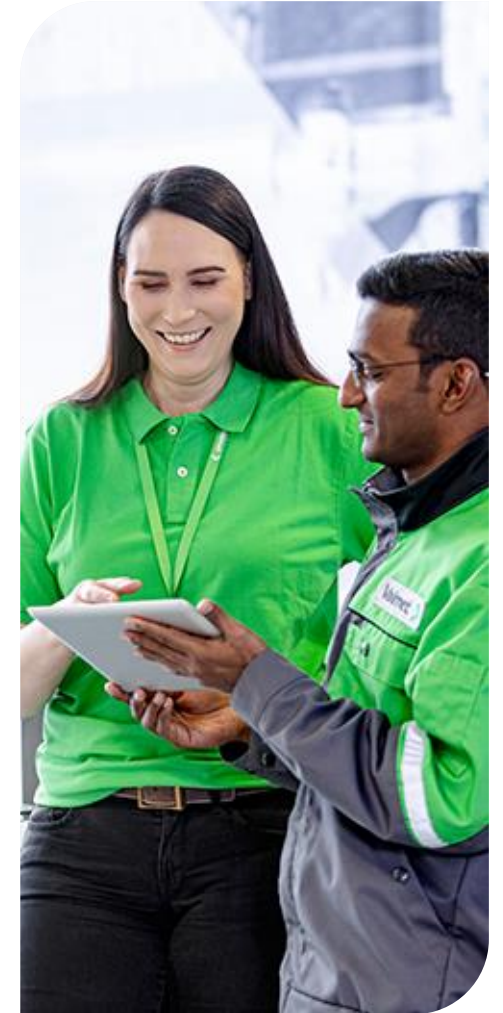

Strong position in the growing market of converting renewables



Process Technologies



Services

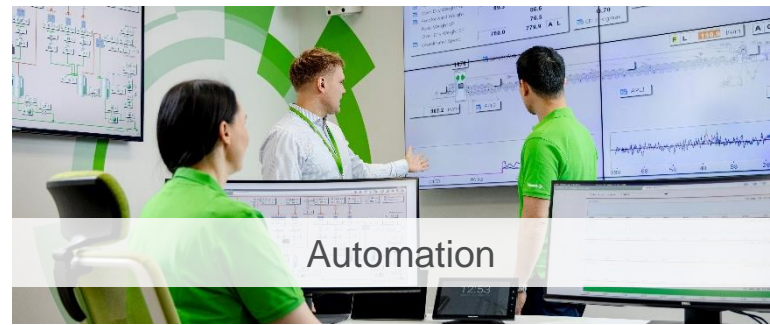

Automation

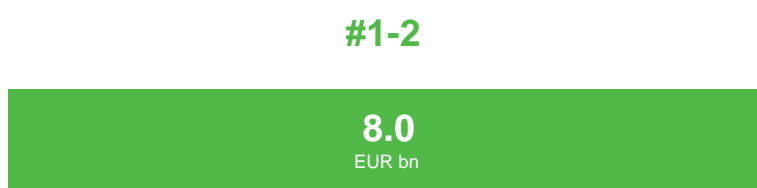

- World trade, e-commerce and emerging markets growth drive demand for packaging board
- Shift from plastic packaging to renewable materials
- Conversions from paper to board
- Rise in purchasing power and living standards drive tissue
- Urbanization and improved hygiene
- Fast economic growth in emerging markets
- Demand for higher quality
- Decarbonization in energy production
- Biomass and residual waste used in heat and process steam production
- Tightening air emissions legislation and stricter directives

- Increasing pulp, tissue, board and energy production
- Customer demand for resource efficiency, productivity, end-product quality and reduced environmental impact
- Customer focus on core, decreasing own resources and outsourcing
- Closures and conversions of non-competitive production lines

- Aging machines and installed automation systems
- Investments in new pulp and paper production lines and industrial decarbonization
- Demand for raw material savings, process efficiencies and sustainability
- Demand for Industrial Internet based solutions driven by customer digitalization

Net sales	Comparable EBITA	Comparable EBITA
2,383	152	6.4%
EUR million	EUR million	margin

Net sales	Comparable EBITA	Comparable EBITA
1,514	213	14.1%
EUR million	EUR million	margin

Net sales	Comparable EBITA	Comparable EBITA
1,176	206	17.5%
EUR million	EUR million	margin

Market position ■ Estimated market size for current offering (EUR) ■ Market drivers ■ Key financial figures (LTM Q3/2022). Automation segment: Figures are illustrative and include Neles figures from Q4/2021-Q1/2022.



Unique offering combining process technology, services and automation

Paper

- Board, paper and tissue production lines
- Rebuilds
- Stand-alone products

Pulp

- Wood and pulp handling
- Fiber processing
- Recovery

Energy

- Heat and power generation
- Air emission control
- Biofuels

Services

- Spare parts and components
- Maintenance and shutdown services
- Outsourcing services
- Production consumables
- Process support and optimization

Flow Control and Automation Systems

- Valves
- Valve automation
- Valve controls
- Distributed control systems (DCS)
- Quality management systems (QMS)
- Analyzers and measurements
- Services and Industrial Internet solutions



EUR 3.0 billion recurring and steadily growing stable business

Orders received
(EUR million)

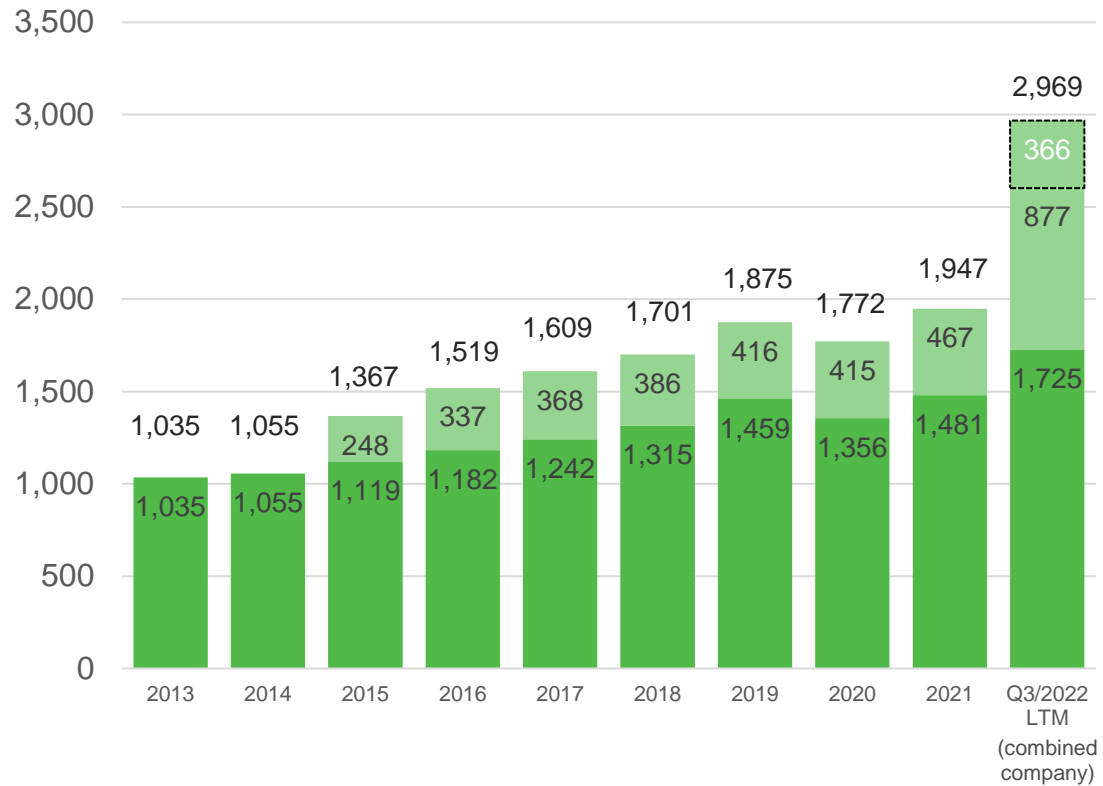

- Valmet’s stable business has grown steadily since 2014
- Future growth possibilities are supported by favorable megatrends
- Stable business provides resilience to business cycles and makes Valmet’s order intake less cyclical

Figures in dark green for Valmet Services segment, light green for Valmet Automation segment. For Q3/2022 LTM (combined company), figures are illustrative, and the light green outlined in black illustrates Flow Control business line Q4/2021-Q1/2022 (i.e., Neles figures). 2013-2020 figures have not been restated.

Services: The widest offering and strong geographical presence

Services business line

- Widest offering to support customers' all service needs
- Benefits from growing installed base
- Strong geographical presence close to customers
- Steady increase in market share from 13% in 2014 to 17–18% in 2020
- Targeting to grow with the market and by winning further market share
- Opportunities to win new customers and increase share of wallet with existing customers

Services business line

Orders received (EUR million)

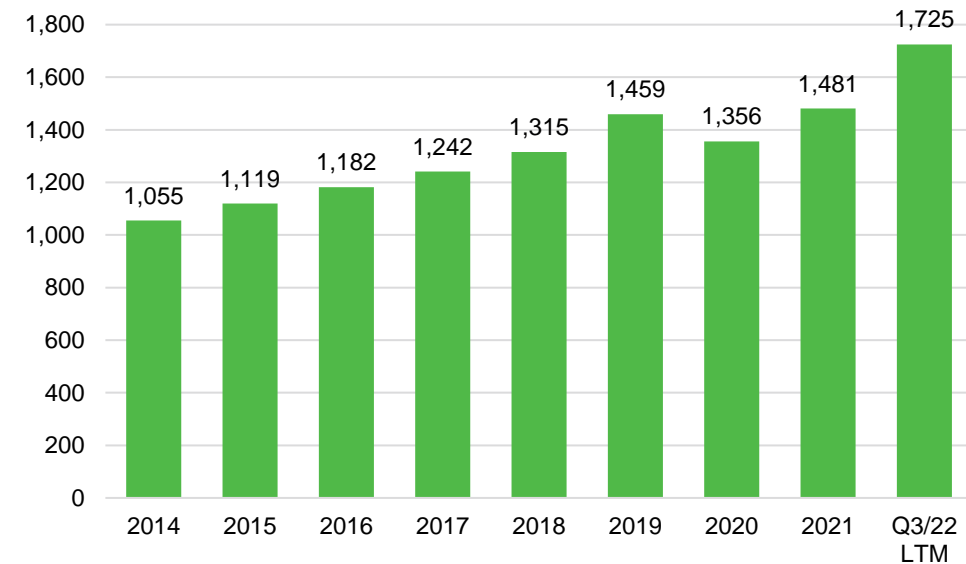

Organic growth
~4%
CAGR in
2014-2019

Flow Control: Strong and diversified offering across many process industries

Flow control business line

- Leading position as a flow control solution provider
- Market leadership in pulp & paper and industrial gases
- A leading global player in downstream oil & gas and petrochemical
- Market leadership in valve controls
- Proven track record of profitable growth and resilient business through economic cycles
- Diversified sales mix by region, customer and industry
- Continued growth in existing and new industries such as metals & mining and renewable energy
- Growing both organically and through selected acquisitions

Flow Control business line

Orders received (EUR million)

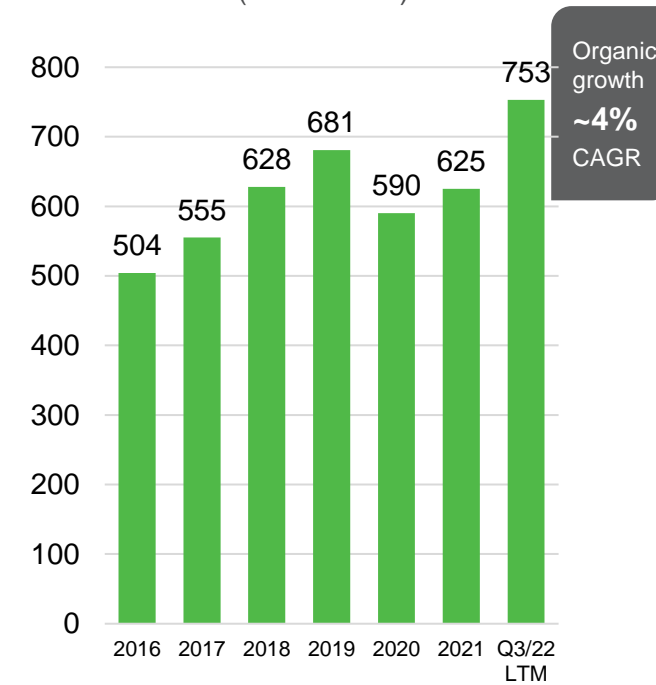

Sales by industry (%), 2021

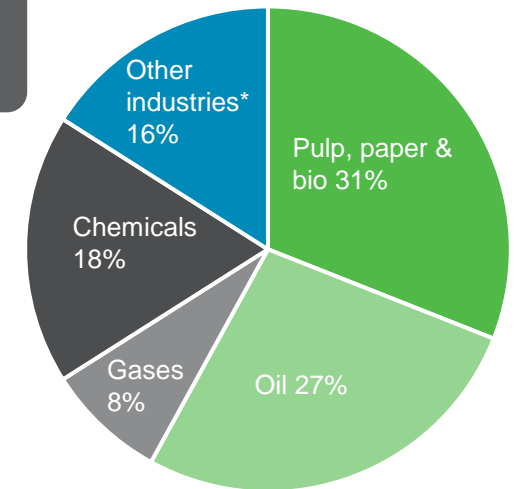

Automation Systems: Maximizing efficiency and safety of our customers

Automation Systems business line

- Solutions range from single measurements to plant-wide process automation systems
- Designed to maximize safety, sustainability and efficiency of customers' businesses
- Securing future competitiveness with R&D
- Strong track record since acquired to Valmet in 2015
- Several drivers for future growth
 - Increasing direct sales to customers
 - Package sales with Valmet's capital equipment
 - Replacing competitors' installed base and entering new industries
 - Growing in automation services

Automation Systems business line

Orders received (EUR million)

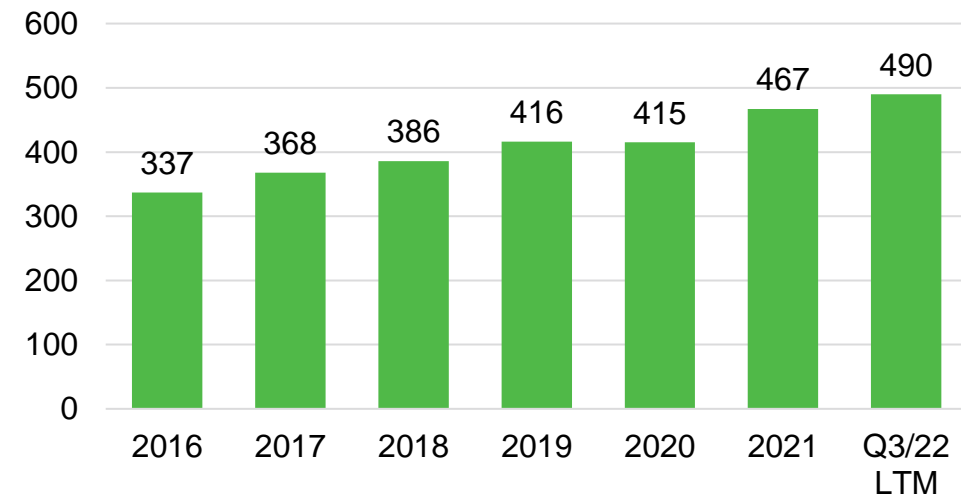

Organic growth
~7%
CAGR

Paper: World-class technology for packaging and hygiene needs

Paper business line

- Offering includes world-leading technology and products for board, tissue and paper making
- Long-term growth supported by favorable megatrends
 - Growing e-commerce and packaging needs
 - Increasing demand for hygiene products
- High market share
- Technological advantage and excellent references
- R&D targeted to introduce new products and improve the existing offering
- Flexible organization and low capacity costs provide resilience to market fluctuations

Paper business line

Orders received (EUR million)

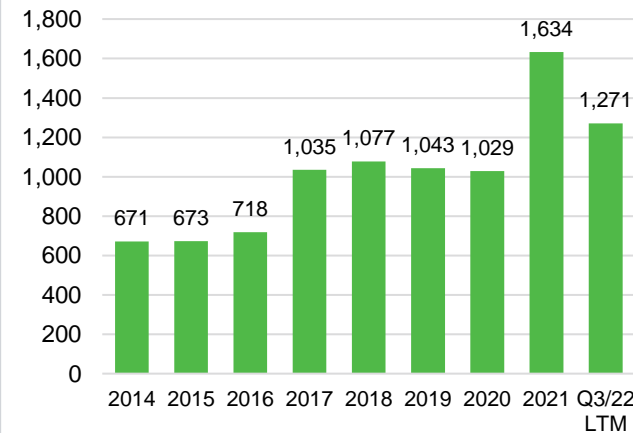

Net sales (EUR million)

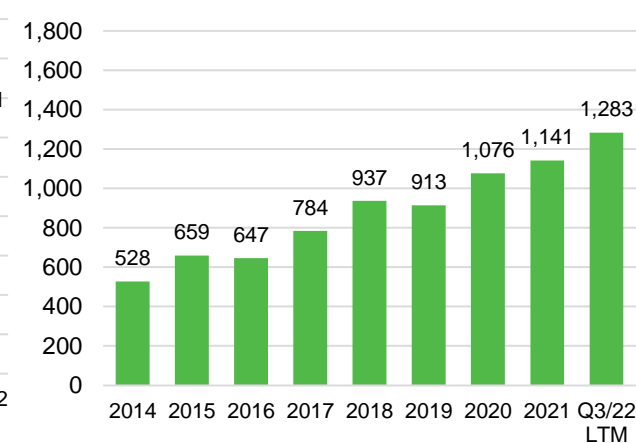

Capacity costs	2015	2021
EUR million	270	343
% of net sales	41%	29%

	Market share	Market position
Board	~50%	#1
Tissue	~35%	#1
Paper	~50%	#1

Pulp and Energy: Strong business with high market share and flexible cost structure

Pulp and Energy business line

- Offering includes full pulp mills and energy solutions for biomass and emission control
- Long-term growth supported by favorable megatrends
 - Growing demand for sustainable packaging and hygiene products and textiles
 - Replacing plastic with fiber-based materials
- High market share
- Technological advantage by focusing on R&D
- Flexible organization and low capacity cost provides resilience to market fluctuations
- Yearly variations in orders received are typical due to timing of large orders

Pulp and Energy business line

Orders received (EUR million)

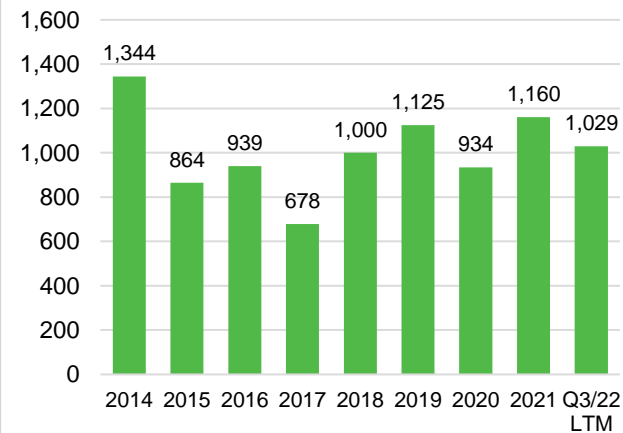

Net sales (EUR million)

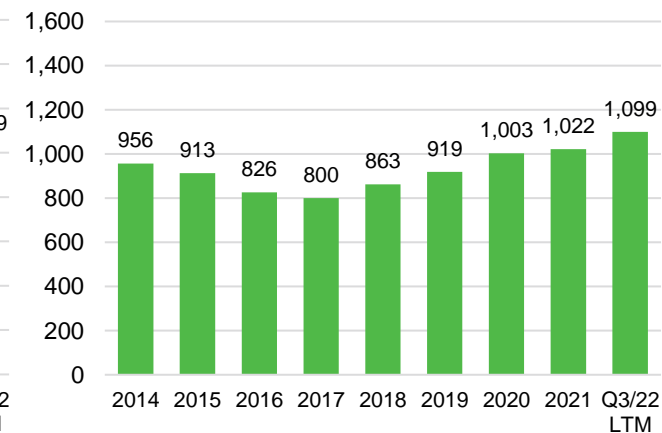

Capacity costs	2015	2021
EUR million	218	206
% of net sales	24%	20%

	Market share	Market position
Pulp	~45%	#1-2
Energy	~20%	#1-3

Systematically building the future with continuous improvement



Customer

Valmet's way to serve:
Lifecycle collaboration
between the customer
and Valmet

Add value to customers
through Industrial
Internet solutions

Ensure strong market
position in capital
business

Continue to increase
market share in the
stable business



Technology

Develop new products
and technologies

- Molded fibre
- Recycled textile fibre
- Lignoboost
- Cellulose based textile fiber

Improve product cost
competitiveness

Increase material and
energy efficiency and
further develop solutions
to reduce carbon
footprint



Process

Continue to improve
project management
and project execution

Valmet's climate
program targeting to
reduce emissions in the
whole value chain



People

Continuous development
of employees through
training programs

Building capabilities
globally

Continue to improve
safety and lower LTIF¹

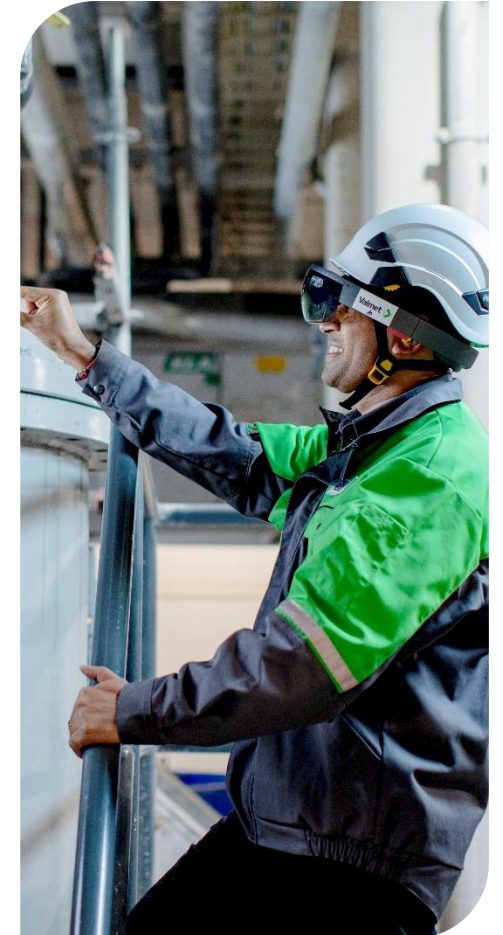

1) LTIF = Lost time incident frequency.



Financials

Key figures

EUR million	Q3/2022	Q3/2021	Change	Q1–Q3/2022	Q1–Q3/2021	Change
Orders received	1,178	1,107	6%	3,809	3,647	4%
Order backlog ¹	4,672	4,199	11%	4,672	4,199	11%
Net sales	1,288	935	38%	3,534	2,736	29%
Comparable EBITA	136	107	27%	337	282	20%
% of net sales	10.5%	11.4%	-0.9 pp	9.5%	10.3%	-0.8 pp
EBITA	132	107	23%	360	293	23%
Operating profit (EBIT)	97	95	3%	280	255	10%
% of net sales	7.6%	10.1%	-2.6 pp	7.9%	9.3%	-1.4 pp
Adjusted earnings per share, EUR ²	0.51	0.53	-4%	1.56	1.40	11%
Earnings per share, EUR	0.38	0.50	-24%	1.25	1.31	-4%
Return on capital employed (ROCE) before taxes ³				15%	21%	-6 pp
Cash flow provided by operating activities	115	57	100%	49	385	-87%
Gearing ¹				18%	-1%	19 pp

Items affecting comparability: EUR -4 million in Q3/2022 (EUR 0 million in Q3/2021) and EUR 23 million in Q1-Q3/2022 (EUR 10 million in Q1-Q3/2021).

1) At end of period

2) Adjusted earnings per share is an alternative performance measure that excludes the impact of fair value adjustments arising from business combinations, net of tax

3) Annualized

Segment key figures

Orders received, EUR million	Q3/2022	Q3/2021	Change	Q1–Q3/2022	Q1–Q3/2021	Change
Services	427	341	25%	1,338	1,094	22%
Automation	306	109	>100%	758	347	>100%
Process Technologies	444	657	-32%	1,713	2,206	-22%
Total	1,178	1,107	6%	3,809	3,647	4%
Net sales, EUR million	Q3/2022	Q3/2021	Change	Q1–Q3/2022	Q1–Q3/2021	Change
Services	381	322	18%	1,101	947	16%
Automation	296	91	>100%	676	252	>100%
Process Technologies	610	522	17%	1,757	1,537	14%
Total	1,288	935	38%	3,534	2,736	29%
Comparable EBITA, EUR million	Q3/2022	Q3/2021	Change	Q1–Q3/2022	Q1–Q3/2021	Change
Services	55	50	9%	142	133	7%
Automation	52	19	>100%	112	39	>100%
Process Technologies	36	46	-23%	107	130	-18%
Other	-7	-8	-16%	-25	-20	25%
Total	136	107	27%	337	282	20%
Comparable EBITA margin, % of net sales	Q3/2022	Q3/2021	Change	Q1–Q3/2022	Q1–Q3/2021	Change
Services	14.3%	15.5%	-1.2 pp	12.9%	14.1%	-1.1 pp
Automation	17.6%	20.5%	-2.9 pp	16.6%	15.4%	1.2 pp
Process Technologies	5.8%	8.9%	-3.0 pp	6.1%	8.5%	-2.4 pp
Total	10.5%	11.4%	-0.9 pp	9.5%	10.3%	-0.8 pp

Comparable EBITA margin development

Net sales and Comparable EBITA (EUR million and %)¹

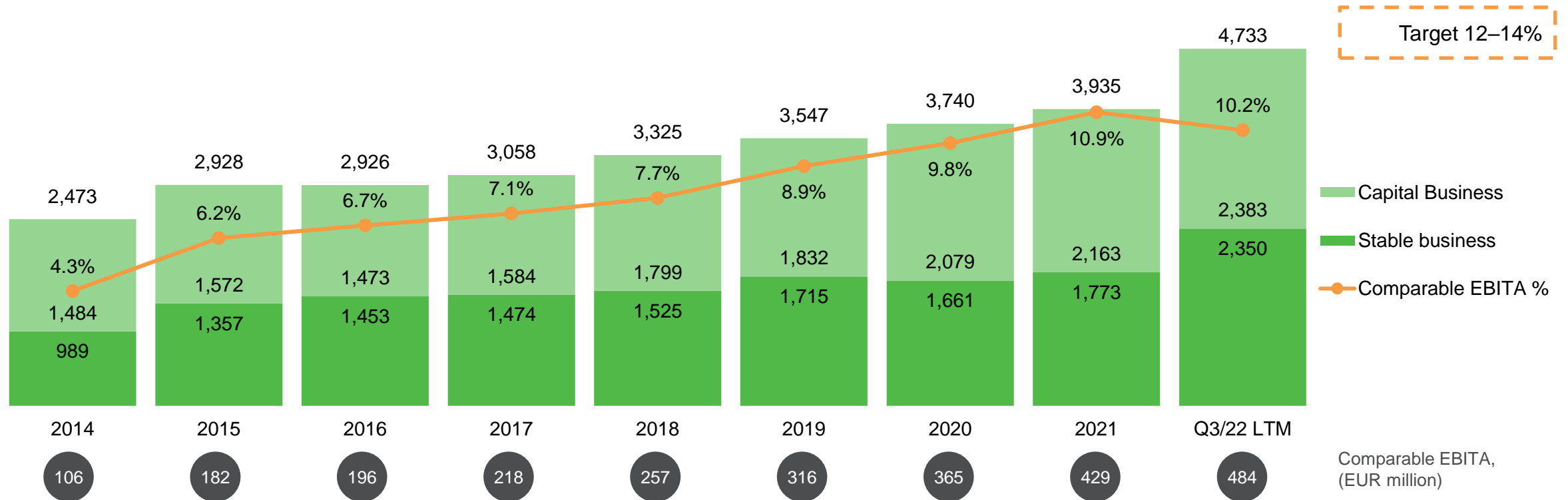

1) Valmet implemented IFRS 15 – Revenue from Contracts with Customers as of January 1, 2018 by applying full retrospective method. 2014–2020 figures have not been restated to reflect Valmet’s current reporting structure. Thus, figures presented are not fully comparable.

Guidance and short-term market outlook

Guidance for 2022 (Published on April 1, 2022)

Guidance	<p>Valmet estimates that, including the merger with Neles, net sales in 2022 will increase in comparison with 2021 (EUR 3,935 million) and Comparable EBITA in 2022 will increase in comparison with 2021 (EUR 429 million).</p>
-----------------	--

Short-term market outlook

		Q4/2021	Q1/2022	Q2/2022	Q3/2022
Services		Good	Good	Good	Good
Automation	Flow Control	Good	Good	Good	Good
	Automation Systems	Good	Good	Good	Good
Pulp and Energy	Pulp	Good	Good	Good / Satisfactory	Good / Satisfactory
	Energy	Satisfactory	Satisfactory	Good	Good
Paper	Board and Paper	Good	Good	Good	Good
	Tissue	Satisfactory	Satisfactory	Satisfactory	Satisfactory

The short-term market outlook is based on customer activity (50%) and Valmet's capacity utilization (50%) and is given for the next six months from the end of the respective quarter. The scale is 'weak-satisfactory-good'.



Summary

Investment highlights

- 1 Strong position in the growing market of converting renewables
- 2 Unique offering combining process technology, services and automation
- 3 EUR 3.0 billion recurring and steadily growing stable business
- 4 Services: The widest offering and strong geographical presence
- 5 Flow Control: Strong and diversified offering across many process industries
- 6 Automation Systems: Maximizing efficiency and safety of our customers
- 7 Paper: World-class technology for packaging and hygiene needs
- 8 Pulp and Energy: Strong business with high market share and flexible cost structure
- 9 Systematically building the future with continuous improvement

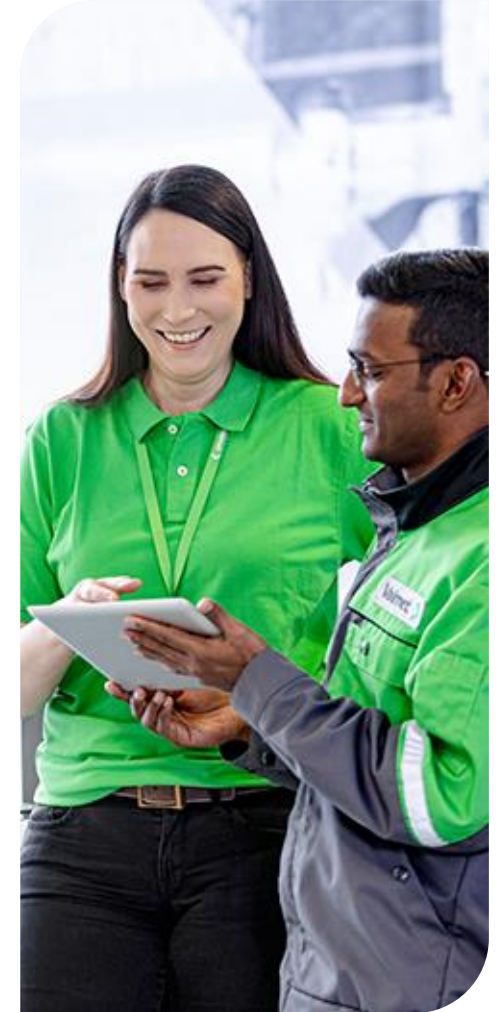

Important notice

It should be noted that certain statements herein which are not historical facts, including, without limitation, those regarding expectations for general economic development and the market situation, expectations for growth, profitability and investment willingness, expectations for company development, growth and profitability and the realization of synergy benefits and cost savings, and statements preceded by “anticipates”, “believes”, “estimates”, “expects”, “foresees” or similar expressions, are forward-looking statements. Since these statements are based on current decisions and plans, estimates and projections, they involve risks and uncertainties which may cause the actual results to materially differ from the results currently expressed. Such factors include, but are not limited to:

- 1) general economic conditions, including fluctuations in exchange rates and interest levels which influence the operating environment and profitability of customers of the company or economic growth in the company’s principal geographic markets.
- 2) industry conditions, intensity of competition situation, especially potential introduction of significant technological solutions developed by competitors, financial condition of the customers and the competitors of the company,
- 3) the company’s own operating factors, such as the success of production, product development and project management and the efficiencies therein including continuous development and improvement
- 4) the success of pending and future acquisitions and restructuring.



Appendix

1 Financials

2 Growth and profitability improvement

3 Shareholders and share price development

4 Strategy and offering

5 Management and remuneration



Appendix
Financials

Quarterly Comparable EBITA margin development

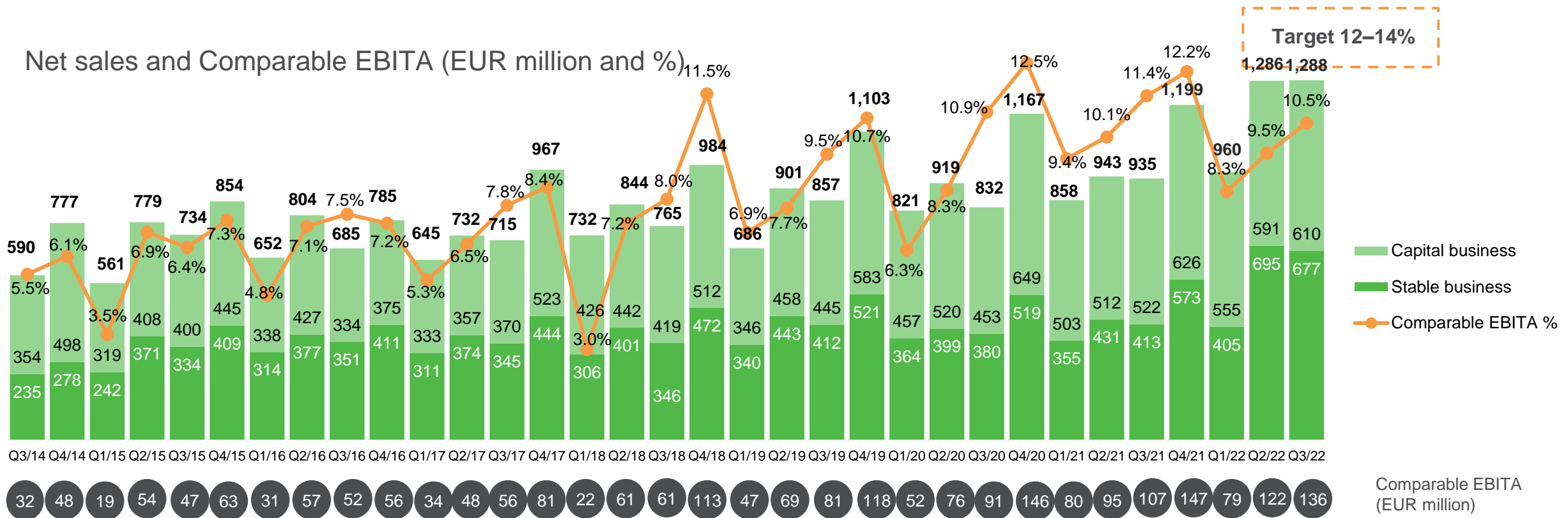

Services: Orders received increased to EUR 1,338 million in Q1–Q3/2022

Orders received (EUR million)

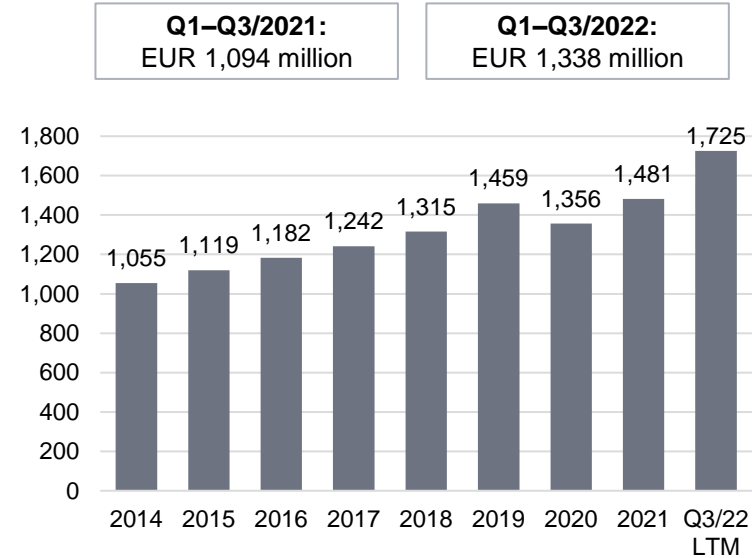

Net sales (EUR million)

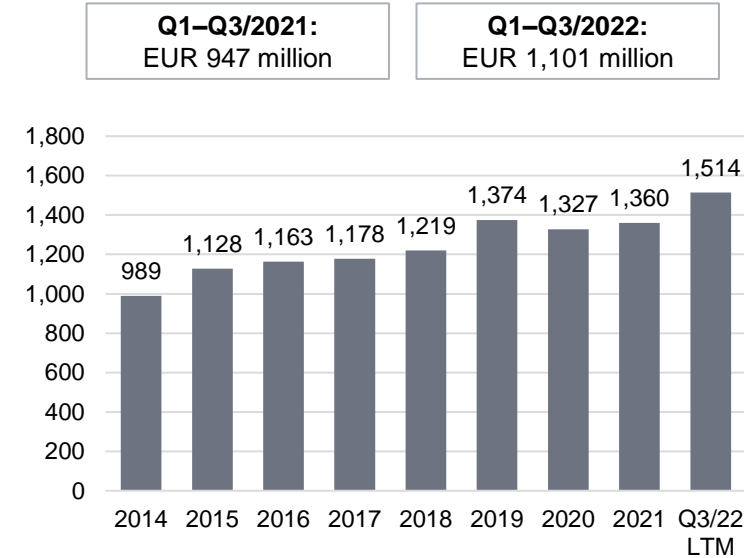

Comparable EBITA (EUR million and % of net sales)

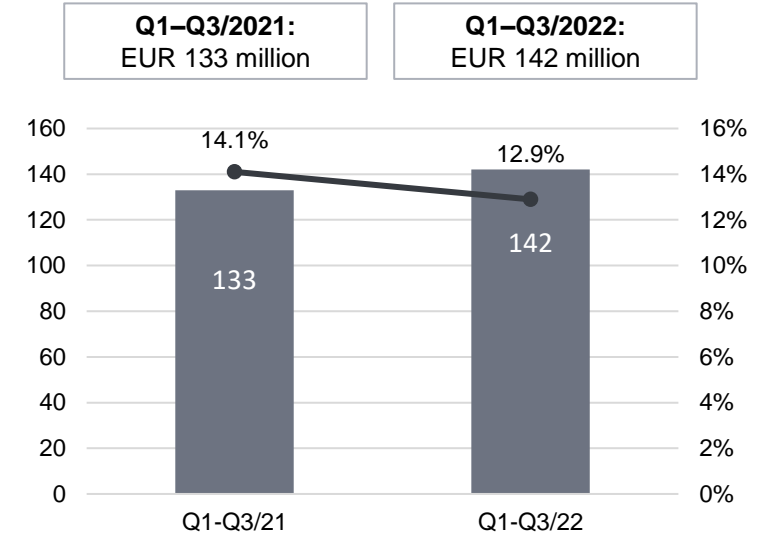

- Orders received increased compared with Q1–Q3/2021
 - Orders received increased in all geographical areas
 - Orders received increased in all businesses
- Net sales increased compared with Q1–Q3/2021
- Comparable EBITA increased compared with Q1–Q3/2021 due to higher net sales, but the margin was lower due to cost inflation
- Services segment was affected by cost inflation, reduced component availability and longer delivery times of certain components in Q1–Q3/2022



Automation: Orders received increased to EUR 758 million in Q1–Q3/2022

Automation segment includes Automation Systems and starting from Q2/2022 also Flow Control

Orders received (EUR million)

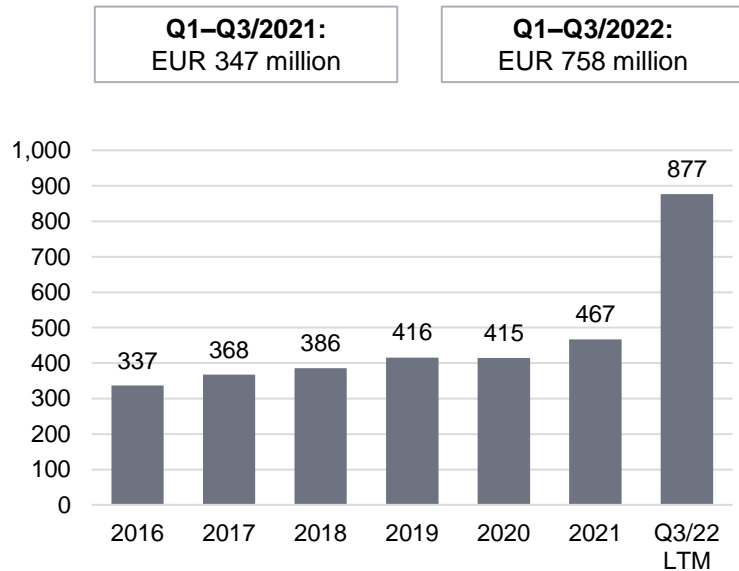

Net sales (EUR million)

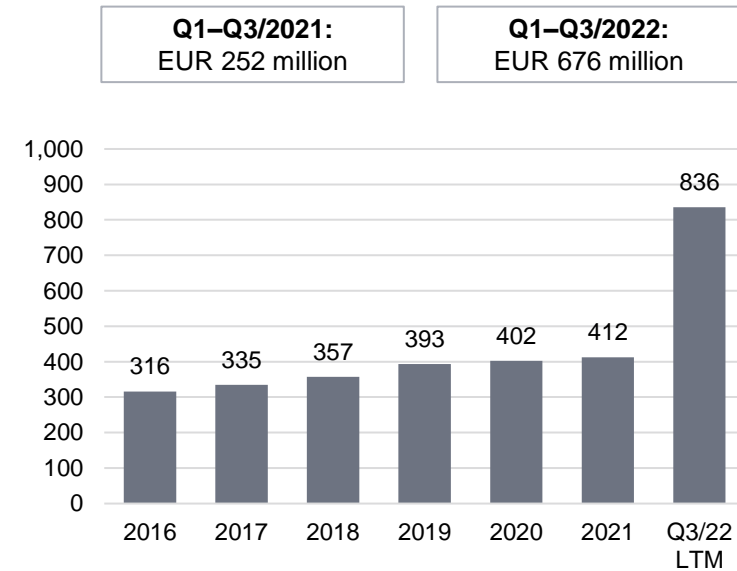

Comparable EBITA (EUR million and % of net sales)

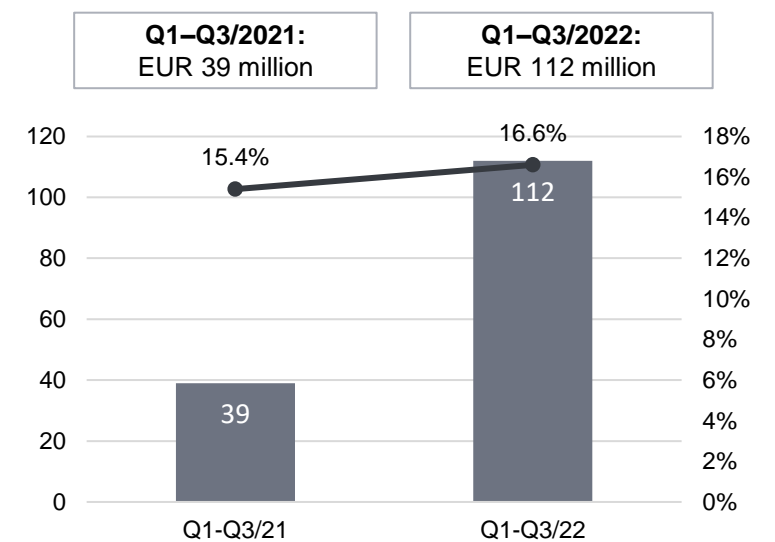

- Orders received increased compared with Q1–Q3/2021
- Net sales increased compared with Q1–Q3/2021
- Comparable EBITA increased compared with Q1–Q3/2021 mostly due to consolidation of Flow Control into Valmet



Flow Control: Orders received amounted to EUR 387 million in Q2–Q3/2022

Orders received (EUR million)*

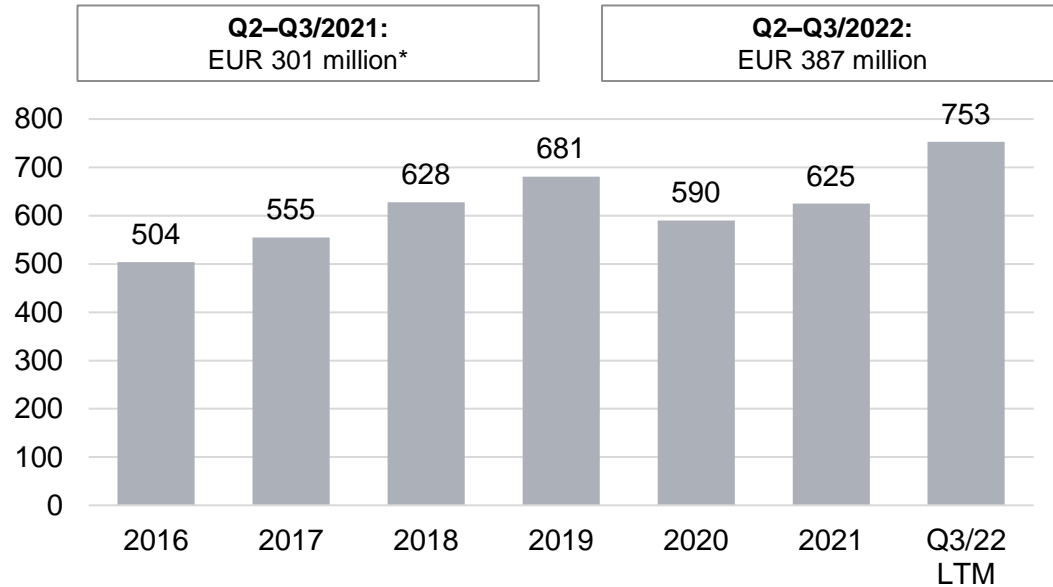

Net sales (EUR million)*

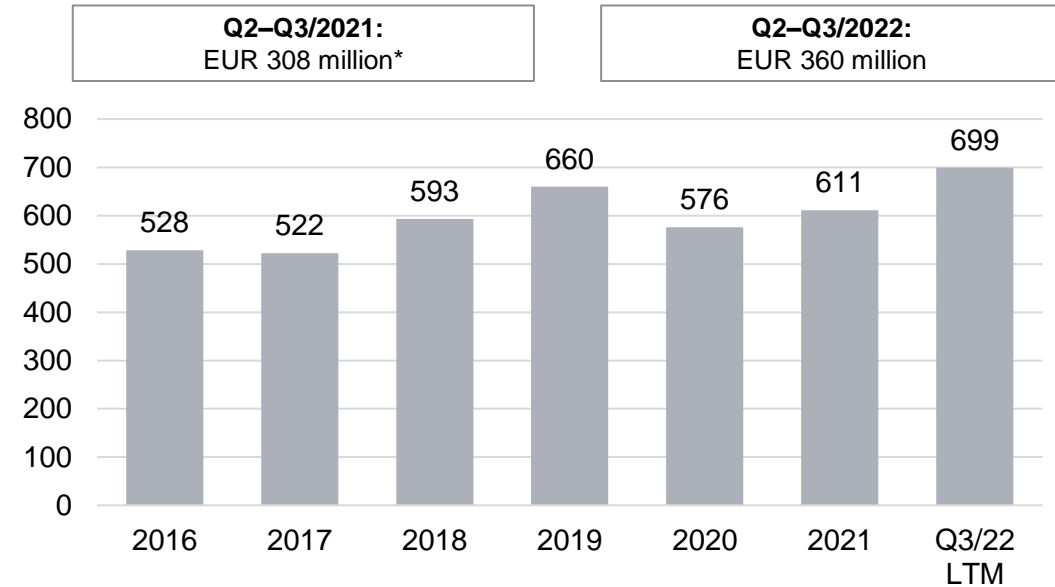

- Orders received amounted to EUR 387 million in Q2–Q3/2022
 - Orders received increased* in South America, North America, EMEA and China, and decreased in Asia-Pacific
- Net sales amounted to EUR 360 million in Q2–Q3/2022
- Reduced component availability and the lockdowns in China earlier in 2022 caused longer lead times for Flow Control in Q3/2022
- Integration of Flow Control into Valmet is proceeding well



* 2016-2017 financials based on carve-out numbers; 2018-2019 financials based on Metso's "Continuing operations" as in 2019 annual report; Q1/2020-Q1/2022 financials as reported in Neles' Q1/2022 interim review.

Automation Systems: Orders received increased to EUR 371 million in Q1–Q3/2022

Orders received (EUR million)

Q1–Q3/2021:
EUR 347 million

Q1–Q3/2022:
EUR 371 million

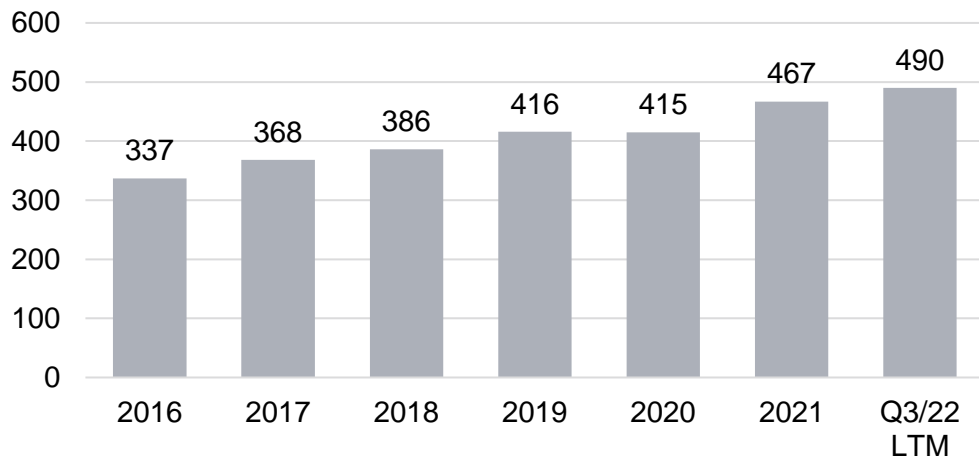

Net sales (EUR million)

Q1–Q3/2021:
EUR 252 million

Q1–Q3/2022:
EUR 317 million

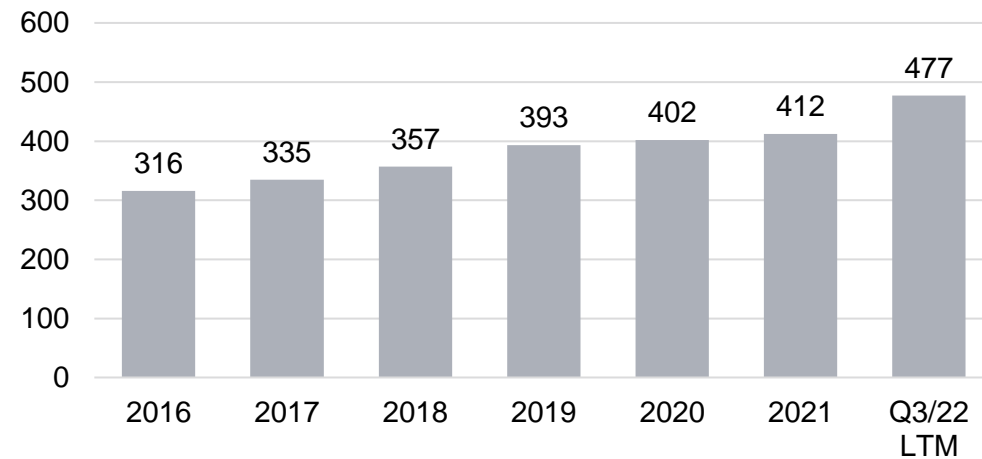

- Orders received increased compared with Q1–Q3/2021
 - Orders received increased in North America and Asia-Pacific, remained at the previous year's level in EMEA, and decreased in South America and China
 - Orders received increased in Energy and Process, and remained at the previous year's level in Pulp and Paper
- Net sales increased compared with Q1–Q3/2021
- Component availability continues at a reduced level and delivery times of certain components were longer during Q1–Q3/2022



Process Technologies: Orders received decreased to EUR 1,713 million in Q1–Q3/2022

Orders received (EUR million)

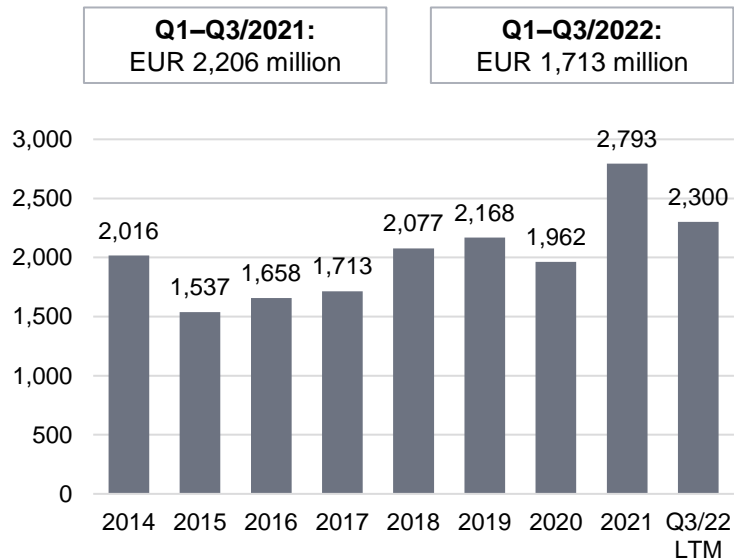

Net sales (EUR million)

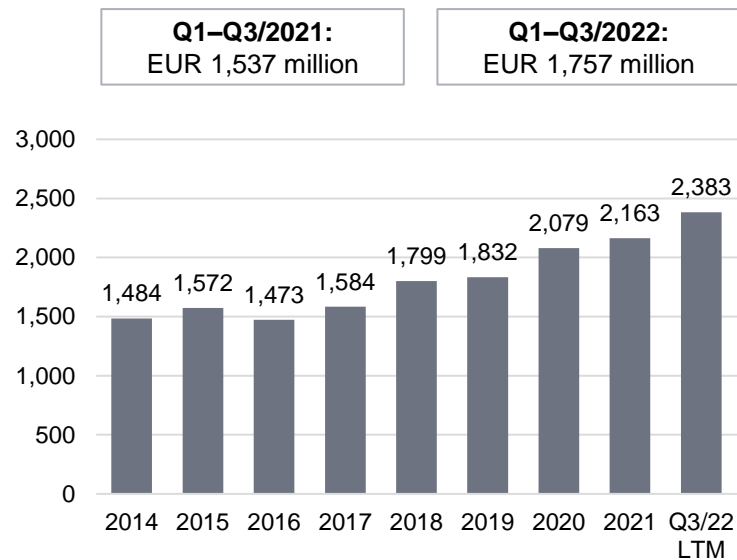

Comparable EBITA (EUR million and % of net sales)

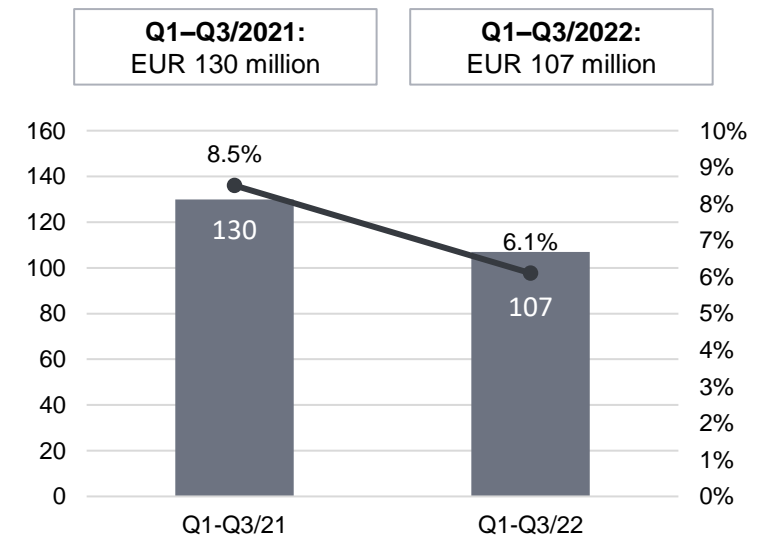

- Orders received decreased compared with Q1–Q3/2021
- Net sales increased compared with Q1–Q3/2021
- Comparable EBITA decreased compared with Q1–Q3/2021, as the margins in some Pulp and Energy projects were impacted by cost inflation



Pulp and Energy business line: Orders received decreased to EUR 792 million in Q1–Q3/2022

Orders received (EUR million)

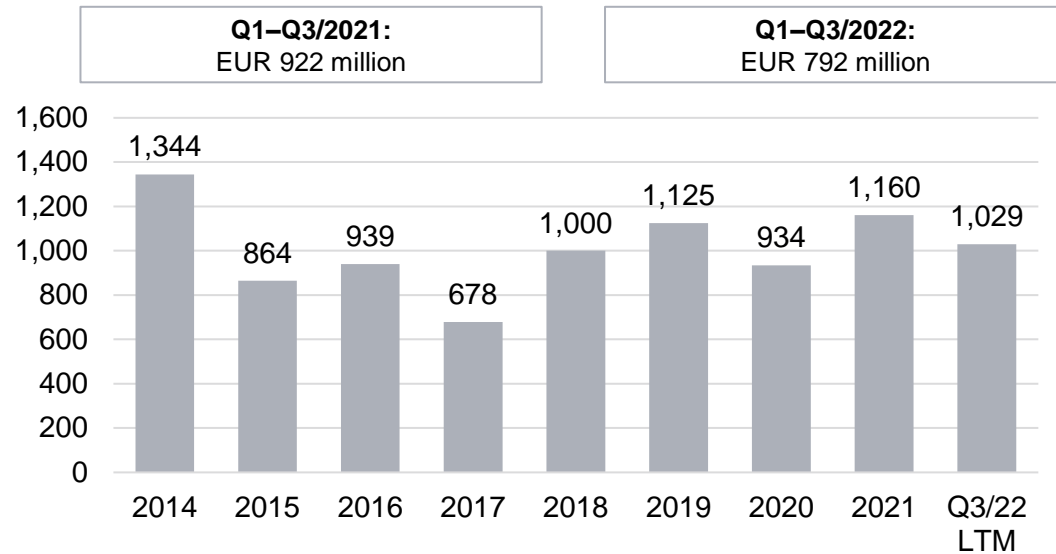

Net sales (EUR million)

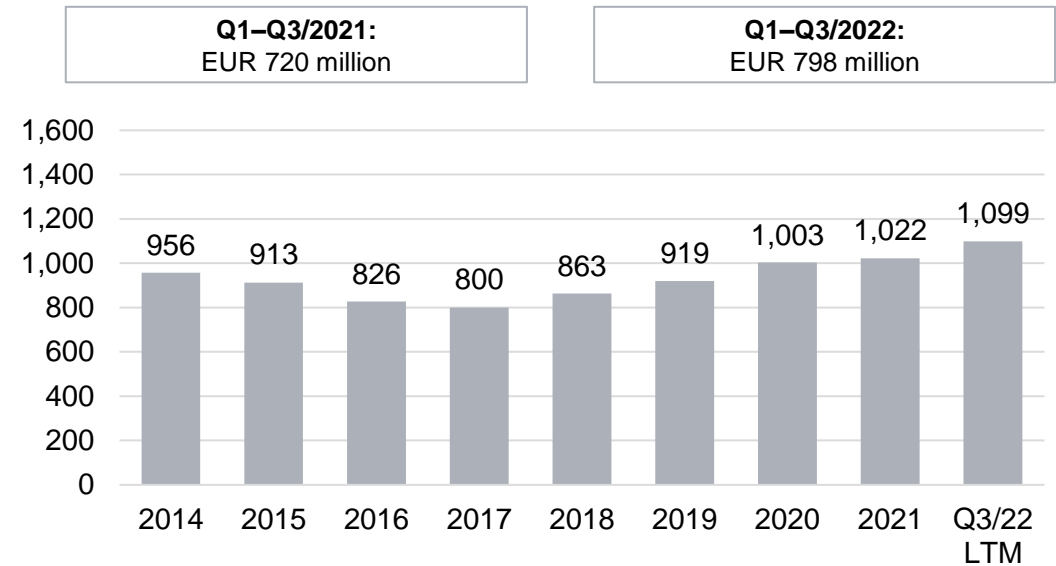

- Orders received decreased compared with Q1–Q3/2021
 - Orders received increased in North America and Asia-Pacific, and decreased in China, South America and EMEA
 - Orders received increased in Energy and decreased in Pulp
- Net sales increased compared with Q1–Q3/2021
- Cost inflation impacted Pulp & Energy’s business environment during Q1–Q3/2022
- The Pulp and Energy business line has managed the challenges caused by COVID-19 well, and the pandemic did not cause major impacts on its operations during Q1–Q3/2022



Paper business line: Orders received decreased to EUR 921 million in Q1–Q3/2022

Orders received (EUR million)

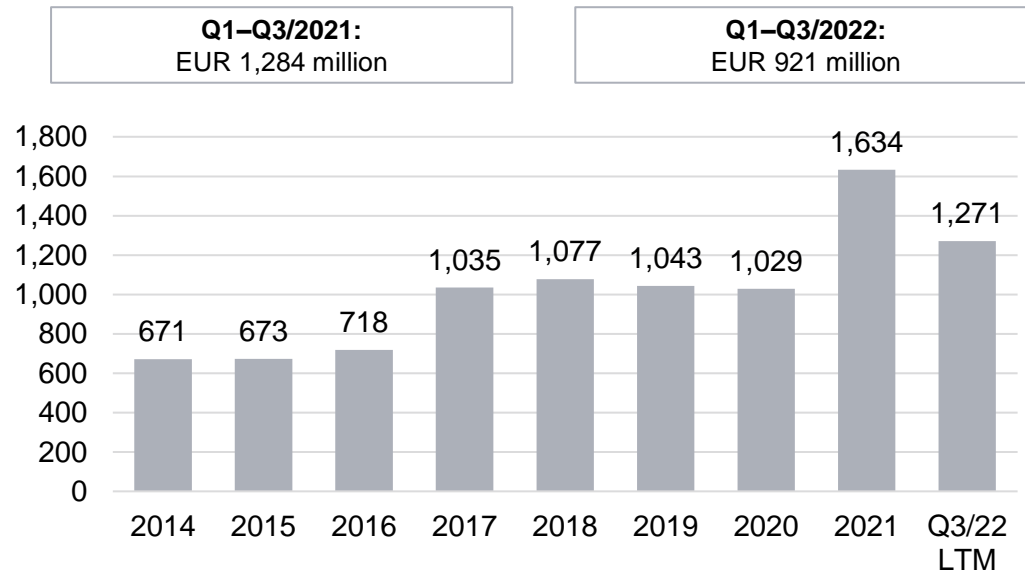

Net sales (EUR million)

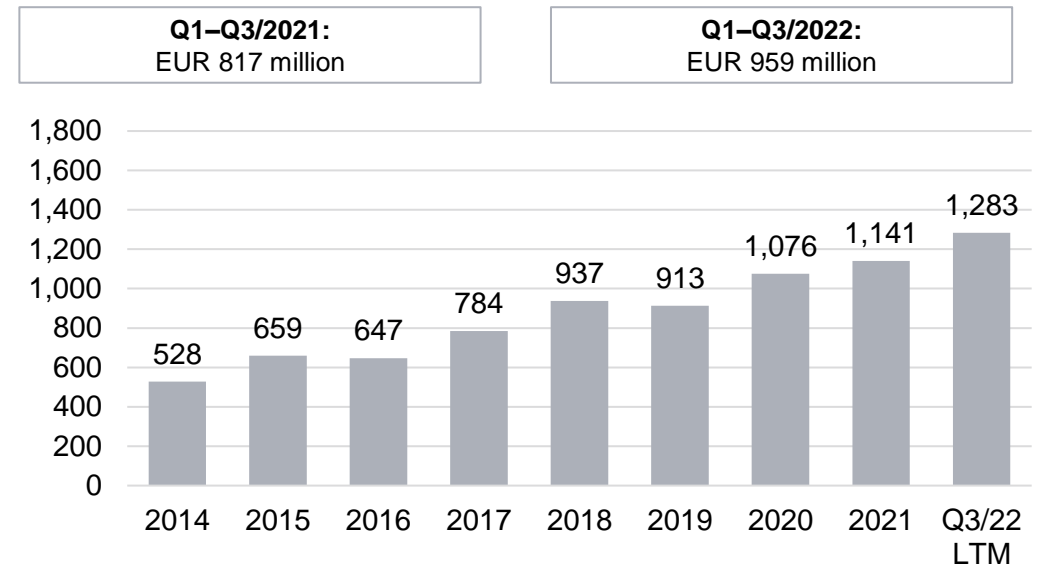

- Orders received decreased compared with Q1–Q3/2021
 - Orders received increased in Asia-Pacific and North America, and decreased in South America, China and EMEA
 - Orders received remained at the previous year's level in Stock preparation, and decreased in all other businesses
- Net sales increased compared with Q1–Q3/2021
- The fire at Rautpohja factory site in Finland, COVID-19 and lockdowns in China impacted Paper business line's operations during Q1–Q3/2022
- The Paper business line has managed the challenges caused by the fire and COVID-19 well

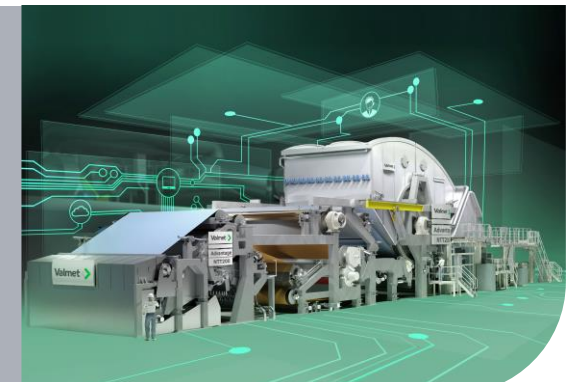

Orders received and net sales split in 2021

Orders received (EUR million and % of total)

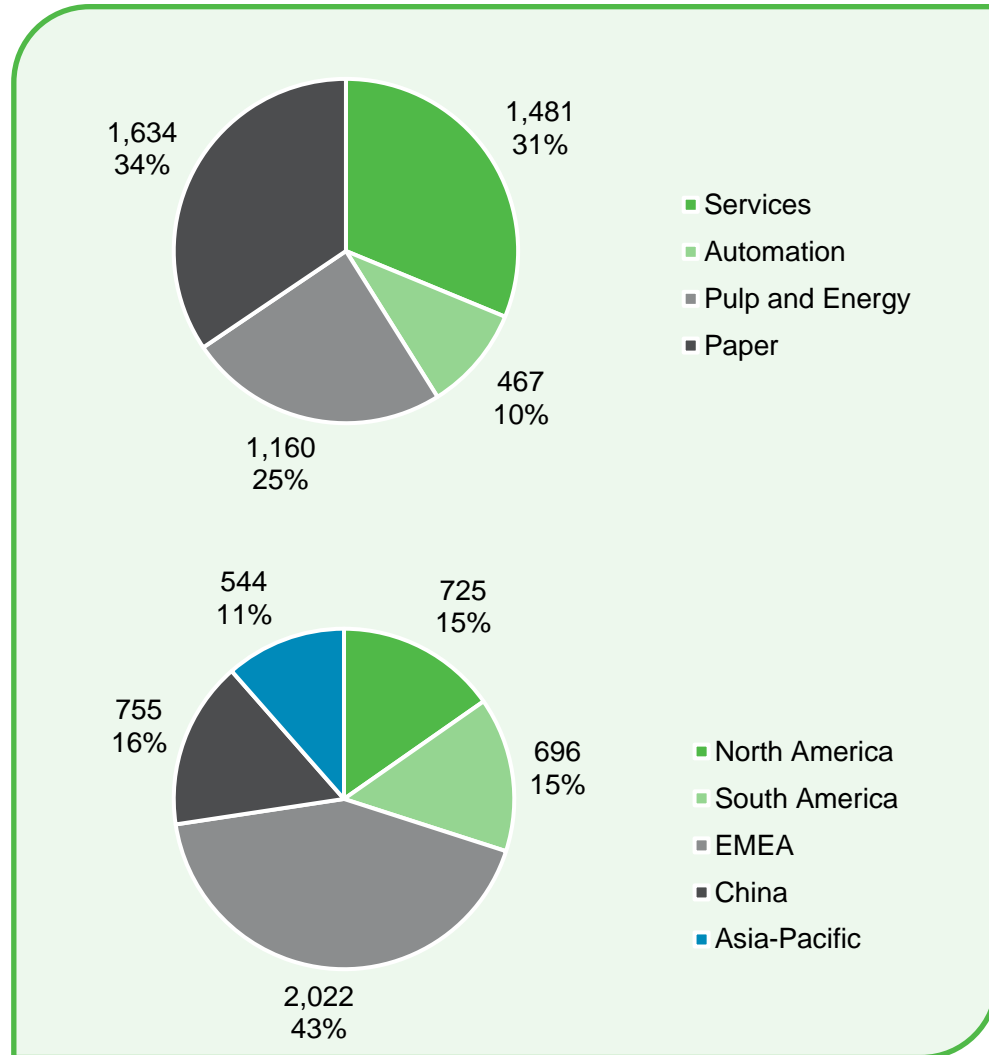

Business line figures restated.

Net sales (EUR million and % of total)

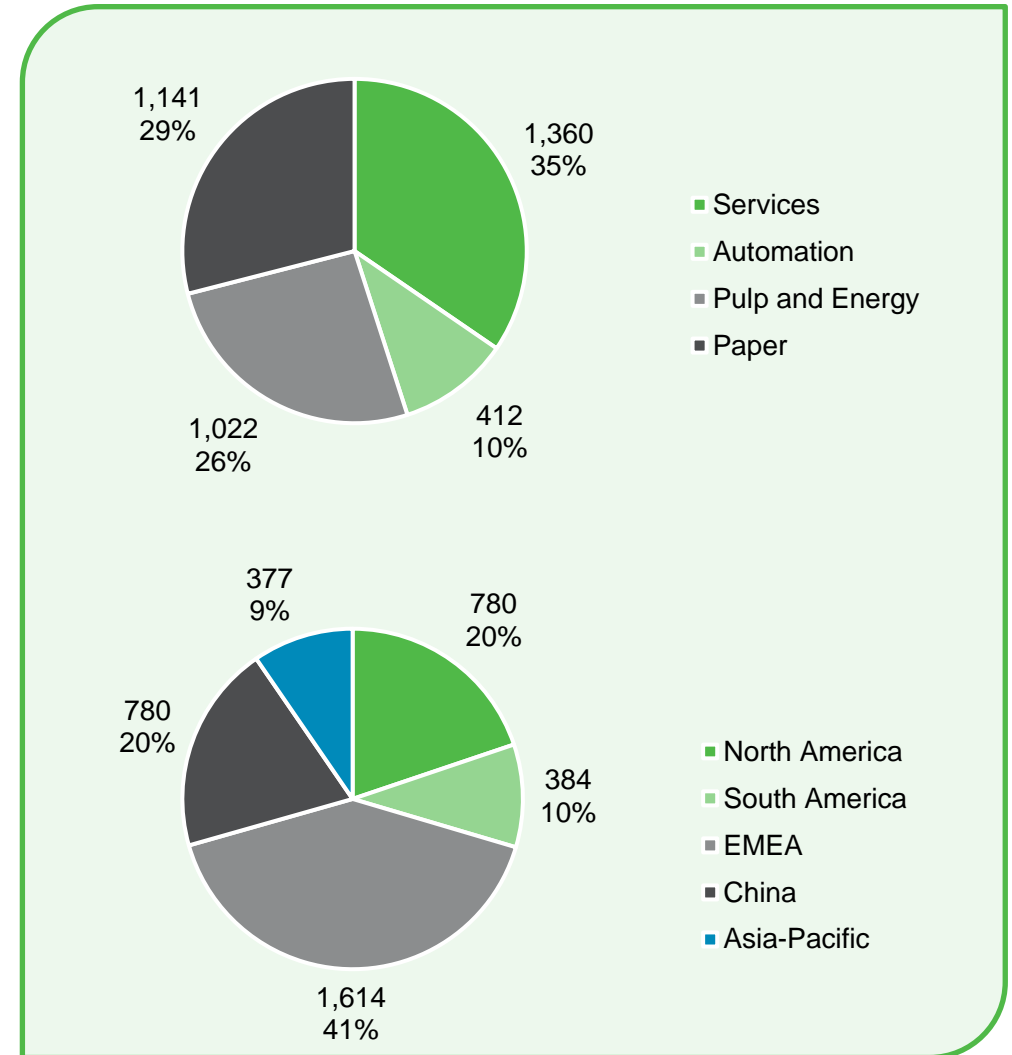

Business line figures restated.

Business lines in 2021: Stable business

Services business line

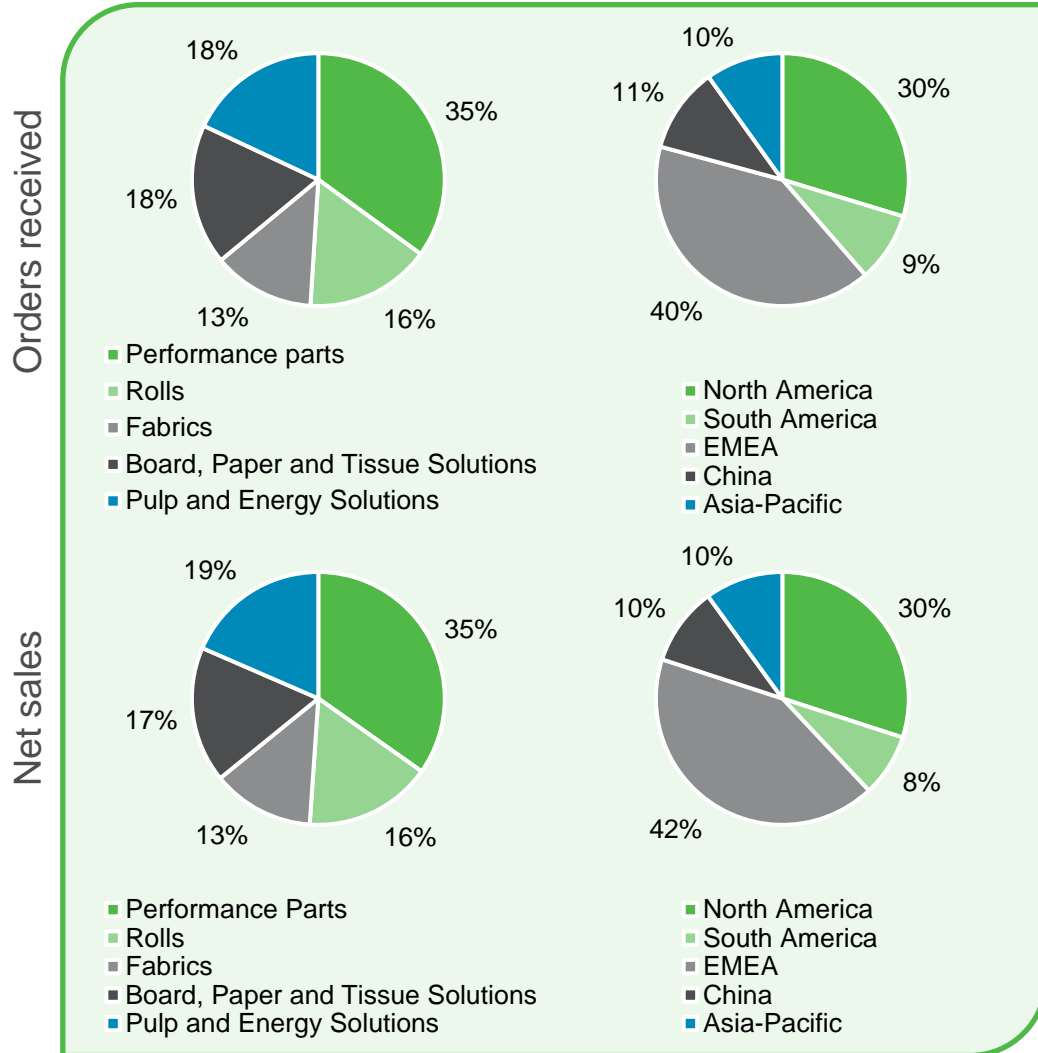

Automation Systems business line

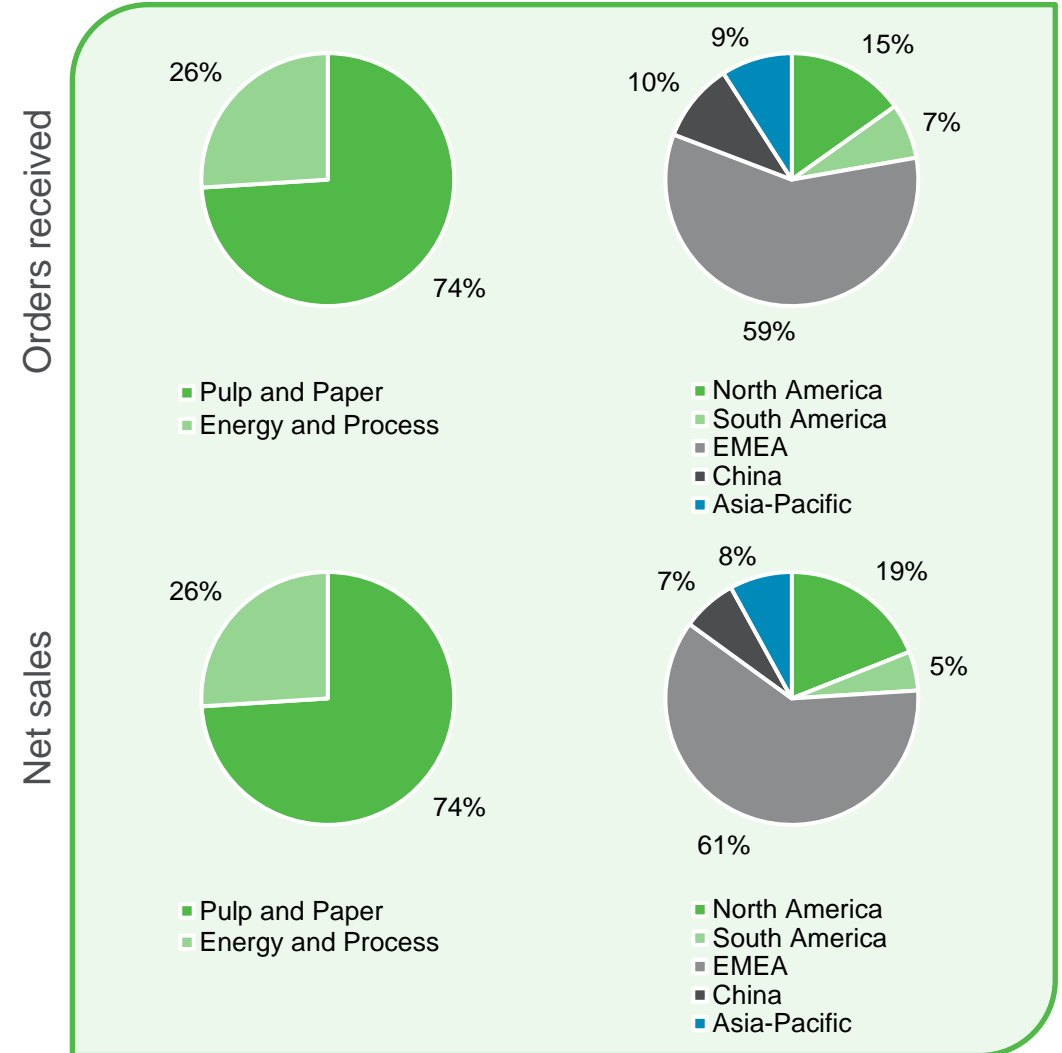

Figures have not been restated.

Split to Pulp and Paper / Energy and Process includes internal orders received and net sales.

Business lines in 2021: Capital business

Pulp and Energy business line

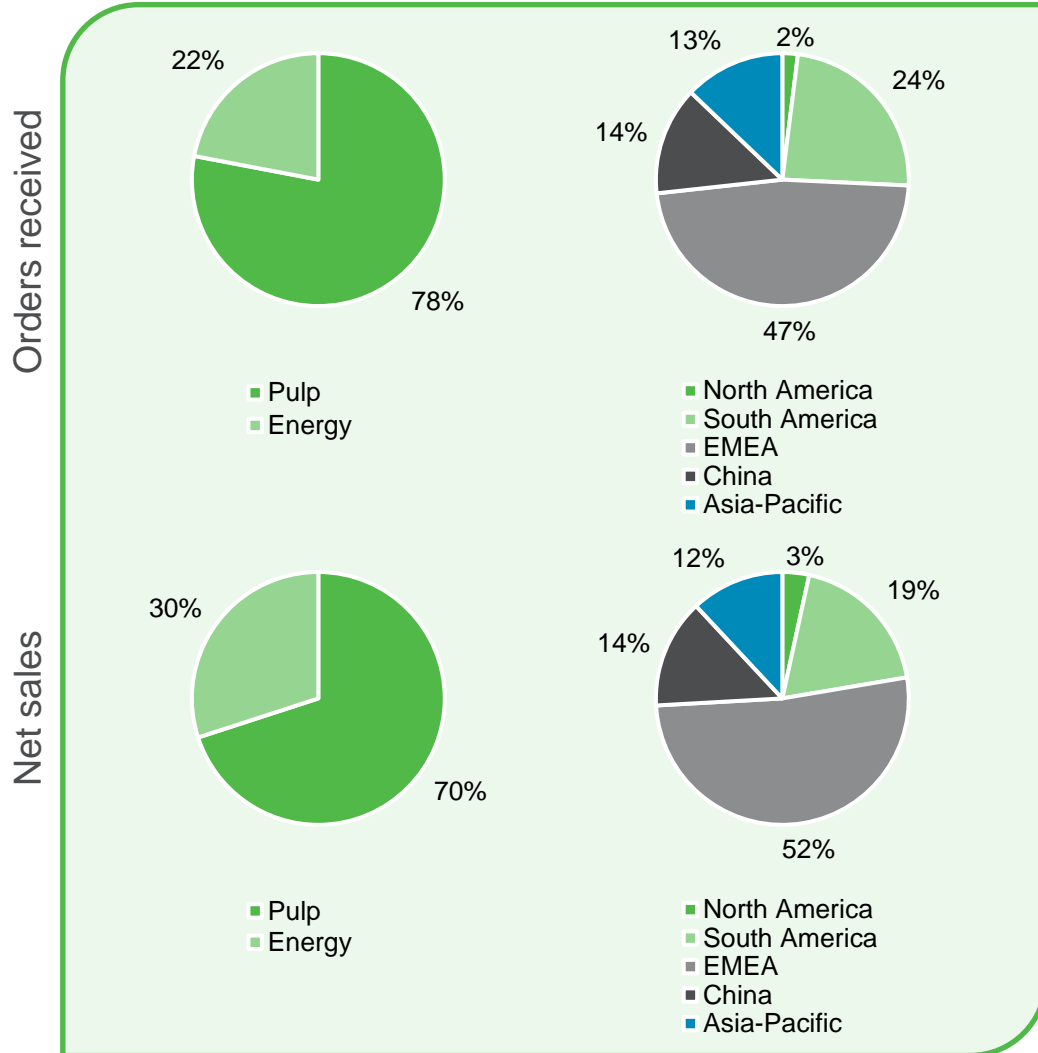

Paper business line

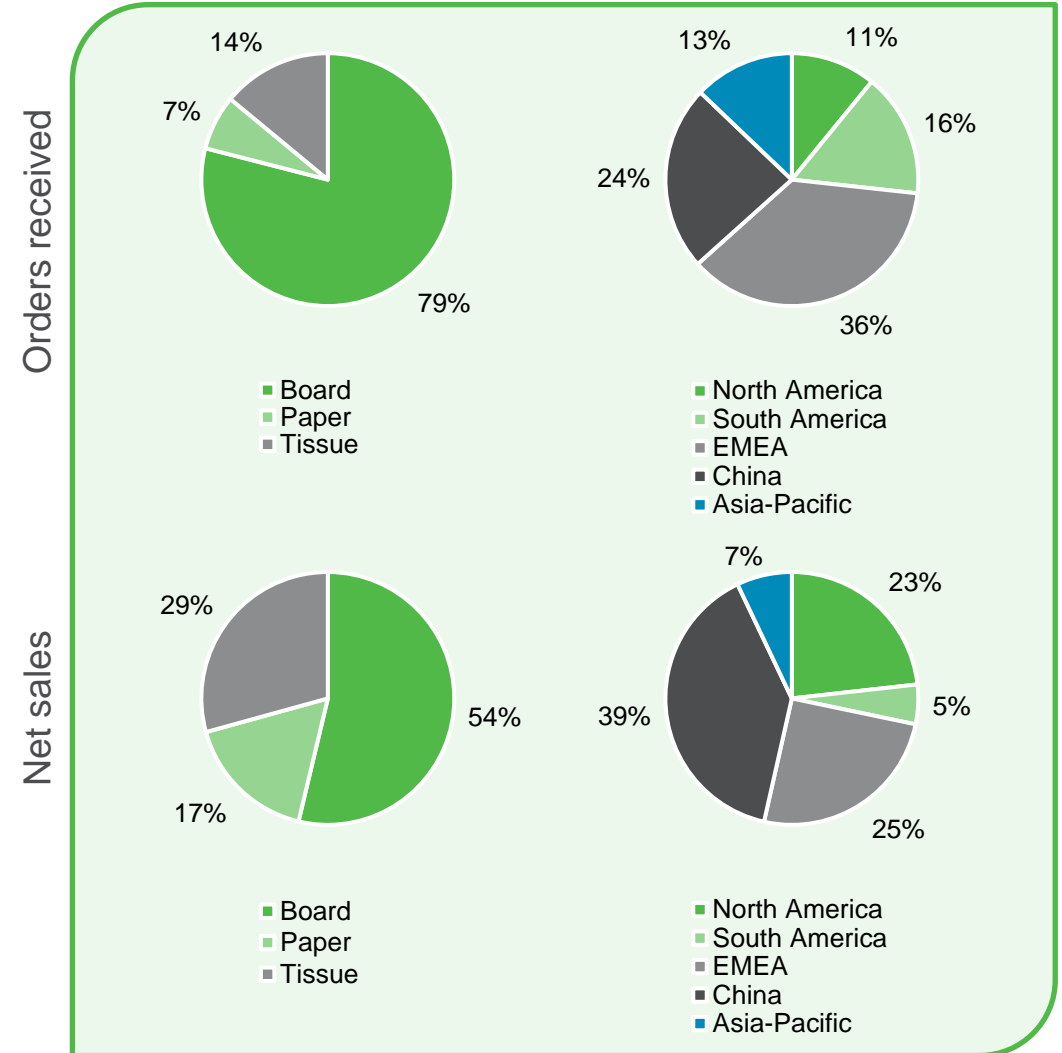

Figures have not been restated.

Figures have not been restated.

Areas: Orders received and net sales development

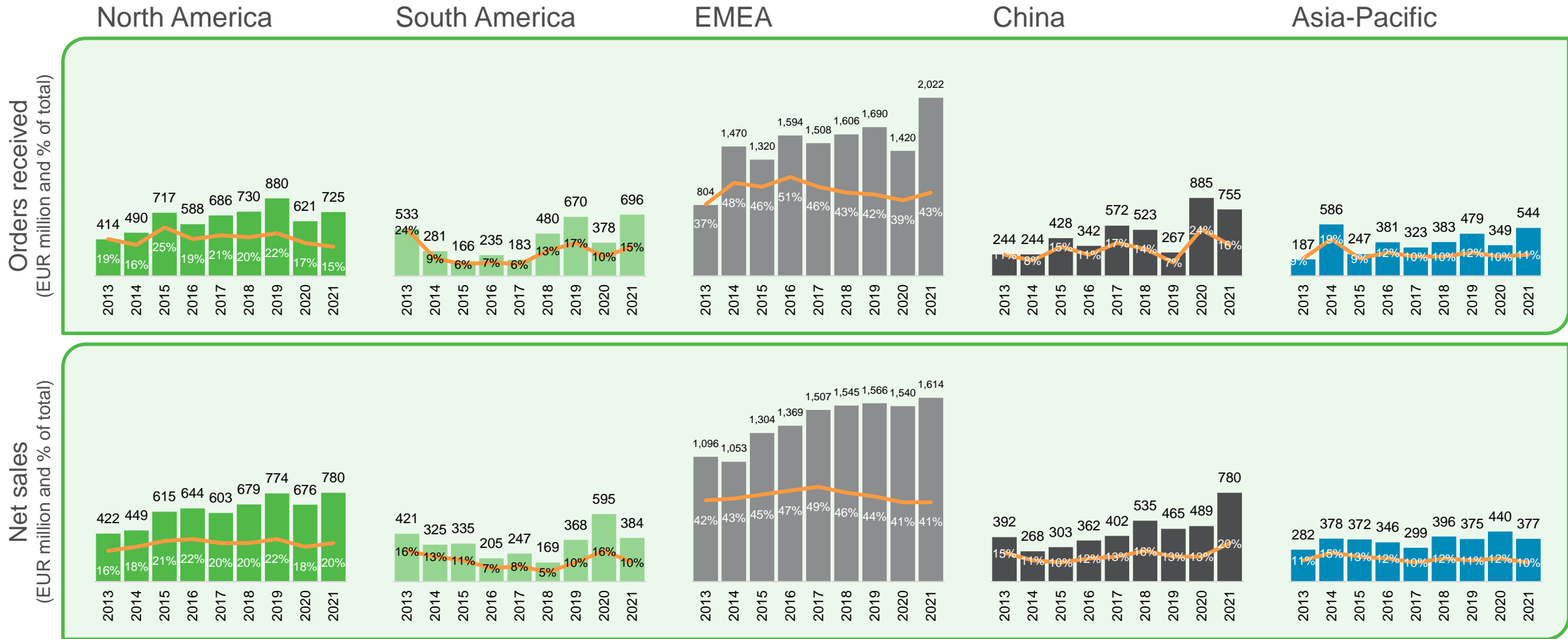

2013 figures on a carve-out basis. Automation business line figures included as of Q2/2015.

Areas: Business line split in 2021

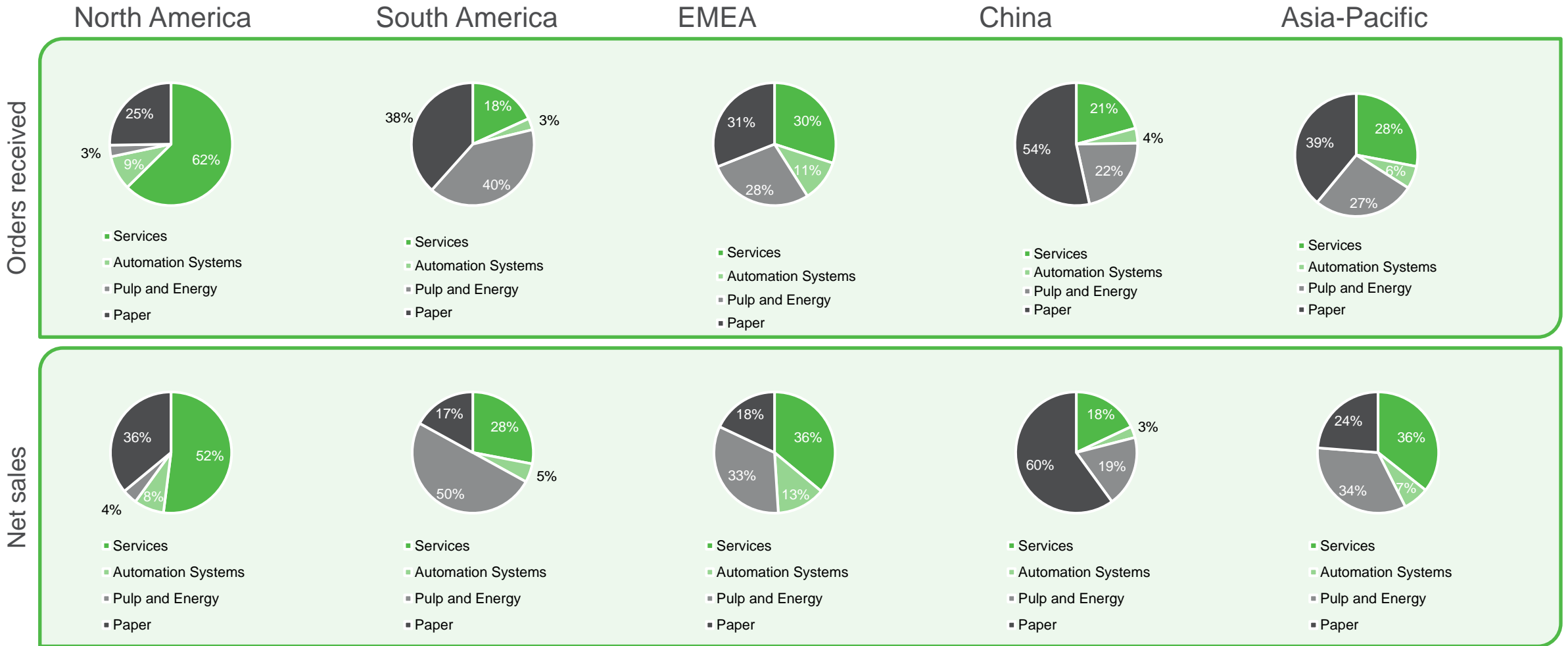

Figures have not been restated.

Announced orders booked in H2/2022

Booked quarter	Date	Description	Business line	Country	Value
Q3	Sep 27	Key technology for Cheng Loong's new board machine	Paper	Vietnam	Not disclosed, but such an order is typically worth between EUR 20 and 30 million.
Q3	Sep 28	A coated board making line	Paper	Asia-Pacific region	Not disclosed. However, a project of this size and scope is typically valued at around EUR 140–180 million.
Q3	Oct 24	Tissue production line to Papel San Francisco	Paper	Mexico	Not disclosed.
Q4	Nov 7	Pyrolyzer plant to Circa Group's ReSolute project	Pulp & Energy	France	Not disclosed.
Q3	Nov 9	Rebuild of Koehler Paper's power boilers	Pulp & Energy	Germany	Not disclosed. The joint value of such rebuilds and supply scopes is typically around EUR 20 million.

Announced orders booked in H1/2022

Booked quarter	Date	Description	Business line	Country	Value
Q1	Feb 2	Waste-to-energy boiler to Thang Long Energy Environment Joint Stock Company	Pulp & Energy	Vietnam	Not disclosed. The value of an order of this type is around EUR 20–30 million.
Q1	Apr 5	Fiberline modernization to CENIBRA	Pulp & Energy	Brazil	Not disclosed. The total value of an order of this type is typically around EUR 25-40 million.
Q1	Apr 13	Sizing section rebuild to Productora Nacional de Papel	Paper	Mexico	Not disclosed. The total value of an order of this type is typically around EUR 15–20 million.
Q1	Apr 28	Fine paper making line to Asia Symbol	Paper	China	Not disclosed. The total value of an order of this type is typically around EUR 80–100 million.
Q1	May 12	BioPower heat and power plant and a pretreatment BioTrac system to ORLEN Poludnie S.A.	Pulp & Energy	Poland	Not disclosed.
Q1	June 28	Two chip washing and defibrator systems to Siempelkamp	Pulp & Energy	Europe and Asia	Not disclosed.
Q2	May 5	OCC, stock preparation and container board lines to Eren Paper	Paper	UK	Not disclosed. The total value of an order of this type is typically around EUR 150–170 million.
Q2	May 11	Completion of biomass boiler, flue gas cleaning and flue gas condensing system works for Vilnius Combined Heat and Power Plant	Pulp & Energy	Lithuania	The total maximum value of the order is around EUR 30 million.
Q2	June 22	Two tissue making lines to Liaoning Yusen Sanitary Products Co., Ltd.	Paper	China	Not disclosed. The total value of an order of this type and delivery scope is typically around EUR 6–8 million.
Q2	July 14	New baling line and flash drying rebuild to MM FollaCell pulp mill in Norway	Pulp & Energy	Norway	The value of this kind of rebuild and scope of supply is typically around EUR 8-10 million.

Announced orders booked in H2/2021

Booked quarter	Date	Description	Business line	Country	Value
Q3	Jul 7	Turnkey biopower plant for the city of Salzburg	Pulp and Energy	Austria	Not disclosed.
Q3	Sep 17	Container board making line to Kipas Kagit	Paper	Turkey	Not disclosed. The total value of an order of this delivery scope is typically around EUR 90-110 million.
Q3	Sep 23	High-capacity winder to Norske Skog	Paper	France	Not disclosed. The value of an order of this type is typically around EUR 10-20 million.
Q3	Sep 27	Coated board making line	Paper	Asia	Not disclosed. The total value of an order of this delivery scope including the BCTMP order booked in Q2/2021 is typically around EUR 200 million.
Q3	Oct 4	Tissue line to Arkhbum Tissue Group	Paper	Russia	Not disclosed. However, a project of this size and scope is typically valued at around EUR 20-40 million.
Q3	Oct 6	Key board machine technology to Zhejiang Forest United Paper	Paper	China	Not disclosed. However, a project of this size and scope is typically valued at around EUR 10 million.
Q3	Oct 14	OptiConcept M board production line	Paper	USA	Not disclosed. The value of an order of this type is typically around EUR 80-90 million.
Q3	Dec 22	Oxygen delignification system to Arkhangelsk Pulp and Paper	Pulp and Energy	Russia	The value of the order will not be disclosed. However, a delivery with this scope of supply is usually valued between EUR 10-15 million.
Q3	Dec 28	Biomass power boiler and a flue gas cleaning system to Tahara Biomass Power LLC	Pulp and Energy	Japan	The value of the order will not be disclosed. A project of this size and scope is typically valued at around EUR 70 million.
Q4	Nov 5	Major technology and automation delivery for CMPC Guaíba pulp mill's modernization project	Pulp and Energy	Brazil	Not disclosed.
Q4	Dec 9	Long-term Performance Agreement and a board machine rebuild to Metsä Board Husum	Paper	Sweden	The value of the order will not be disclosed. The total value of an order of this type and delivery scope is typically around EUR 70–80 millions.
Q4	Dec 15	Old Corrugated Containers, stock preparation and OptiConcept M container board making lines to Kivanç Tekstil Sanayi Ve Ticaret	Paper	Turkey	The value of the order will not be disclosed. A project of this size and scope is typically valued at around EUR 60–70 million.
Q4	Dec 16	Grade conversion rebuild to VPK's Alizay	Paper	France	Not disclosed.
Q4	Dec 21	Extensive recycled fiber line and paper machine grade conversion rebuild to Model Paper Eilenburg	Paper	Germany	The value of the order will not be disclosed. The total value of an order of this type and delivery scope is typically around EUR 90–100 million.
Q4	Jan 20	Board machine rebuild to Stora Enso	Paper	Sweden	The value of the order will not be disclosed. The total value of an order of this type and delivery scope is typically around EUR 30-40 million.

Orders received increased to EUR 1,178 million in Q3/2022

Orders received (EUR million)

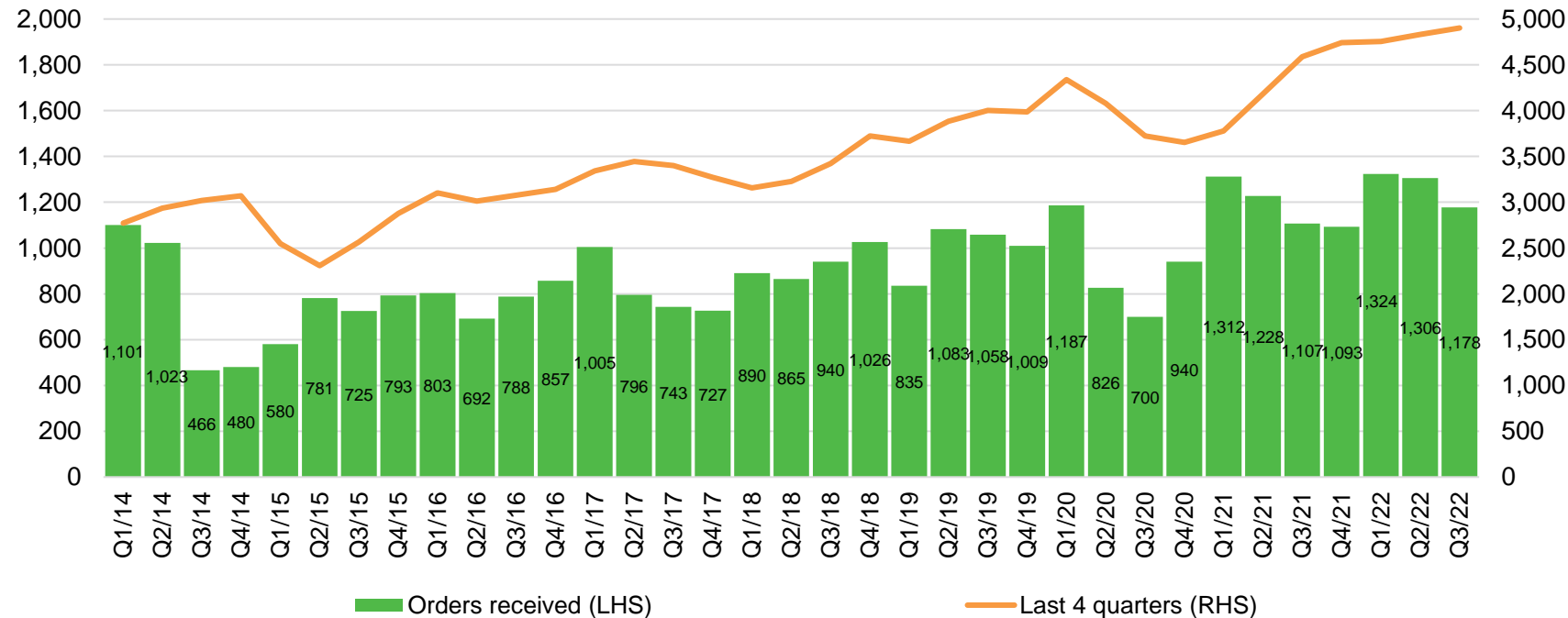

Orders received in Q1–Q3/2022 by area

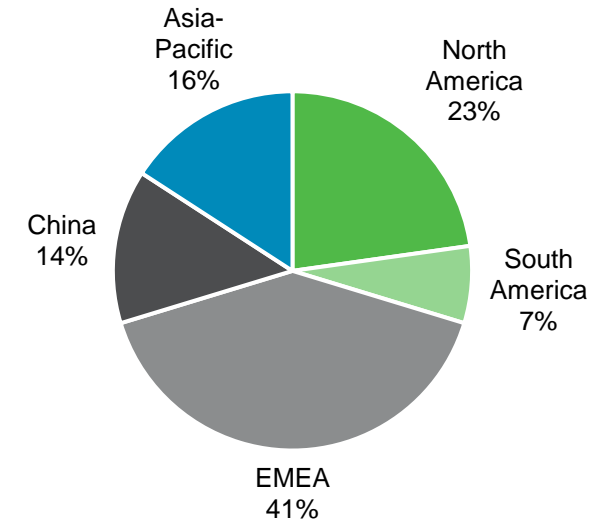

- Orders received increased in North America, Asia-Pacific and EMEA and decreased in South America and China in Q1–Q3/2022 compared with Q1–Q3/2021
 - South America, China and Asia-Pacific together accounted for 37% of orders received

Stable business orders received totaled EUR 2,602 million during the last twelve months

Orders received (EUR million) in stable business

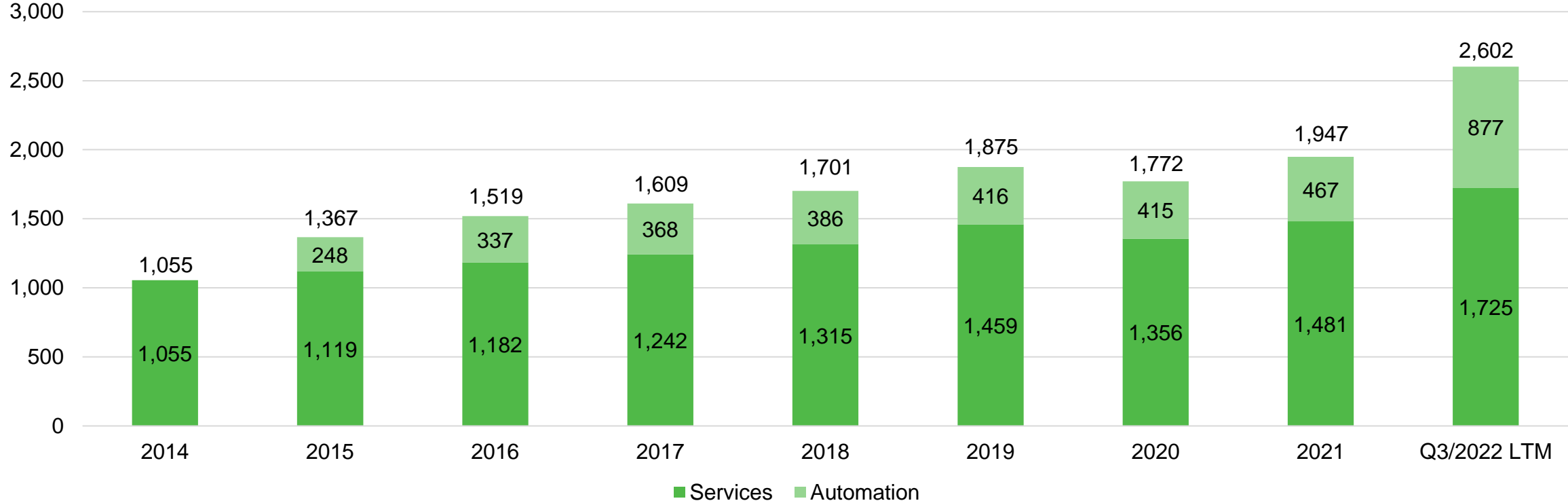

- Total orders received in stable business were EUR 283 million higher in Q3/2022 compared with Q3/2021

2014-2020 figures have not been restated and 2015-2020 figures include internal orders received for the Automation Systems business line.

Order backlog EUR 4,672 million at the end of Q3/2022

Order backlog (EUR million)

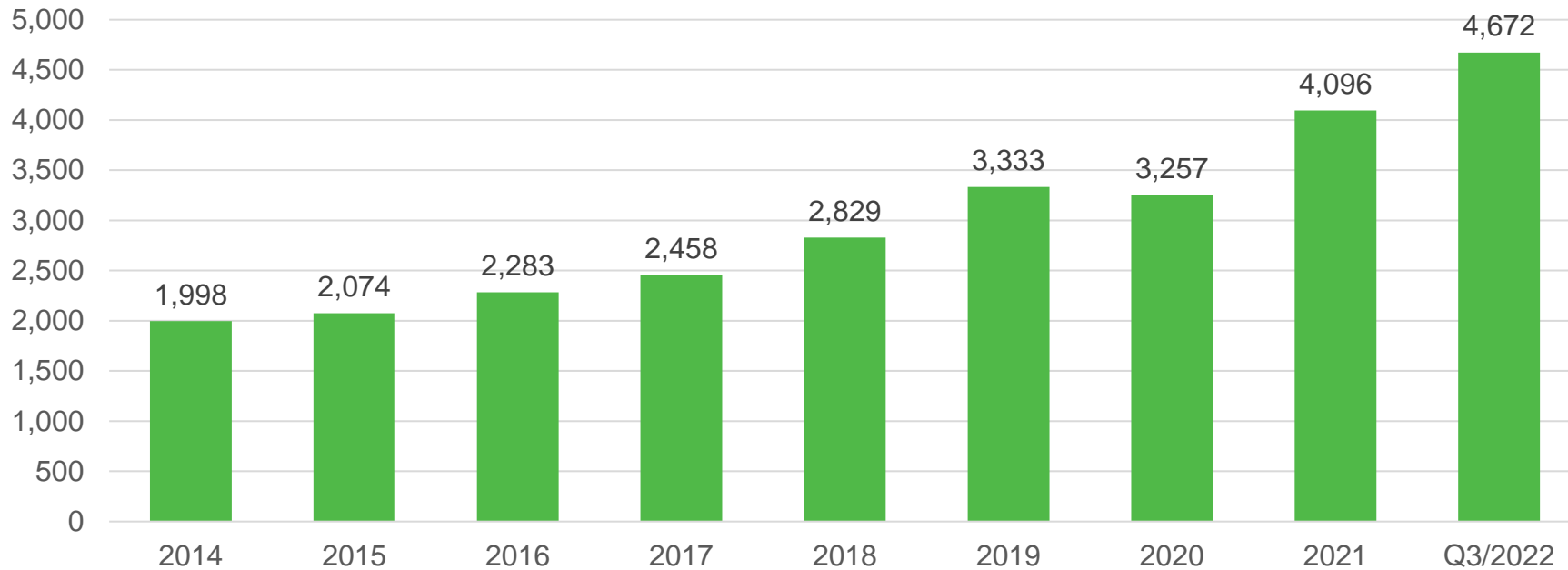

Structure of order backlog by segment

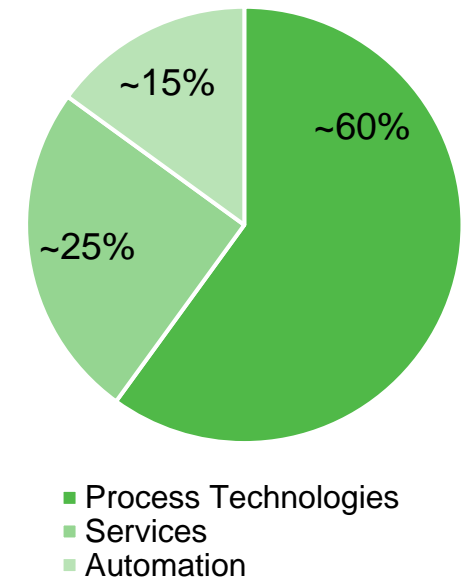

- Order backlog was EUR 576 million higher than at the end of 2021
- Approximately 40% of the order backlog relates to stable business (~25% at the end of Q3/2021)

Gross profit and SG&A development

Gross profit (EUR million and % of net sales)

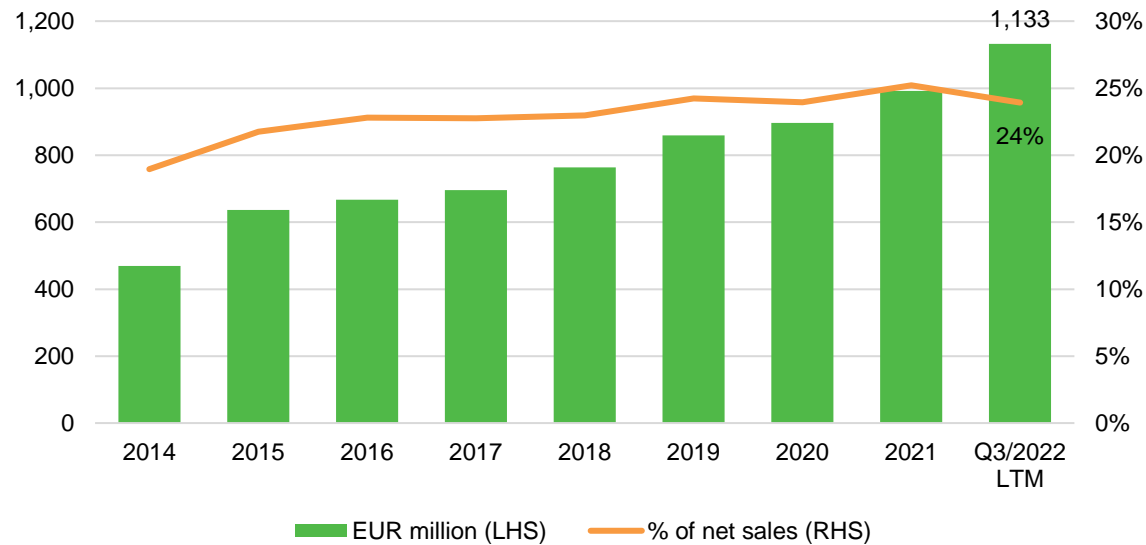

SG&A (EUR million and % of net sales)

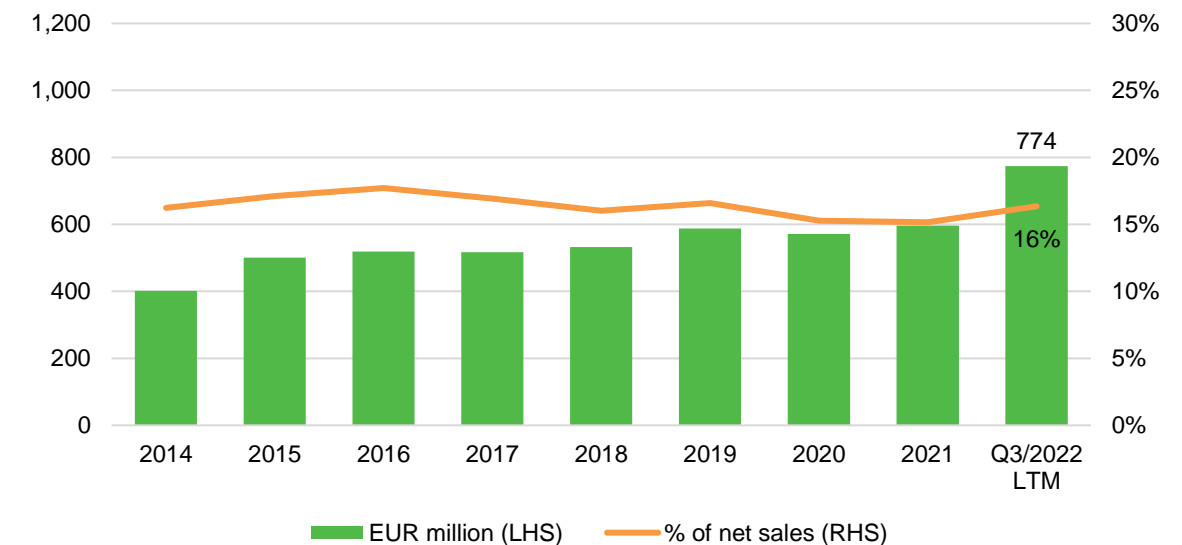

- Gross profit was 24% of net sales in Q3/2022 (25% in Q3/2021)
 - Stable business represented 53% of net sales (44% in Q3/2021)
- Selling, general & administrative (SG&A) expenses were EUR 77 million higher in Q3/2022 compared with Q3/2021
 - SG&A of the Flow Control business line were EUR 54 million in Q3/2022
 - SG&A was 17% of net sales in Q3/2022 (15% in Q3/2021)

Capital employed, Comparable ROCE and EPS

Capital employed (EUR million) and Comparable return on capital employed (ROCE), before taxes (%)

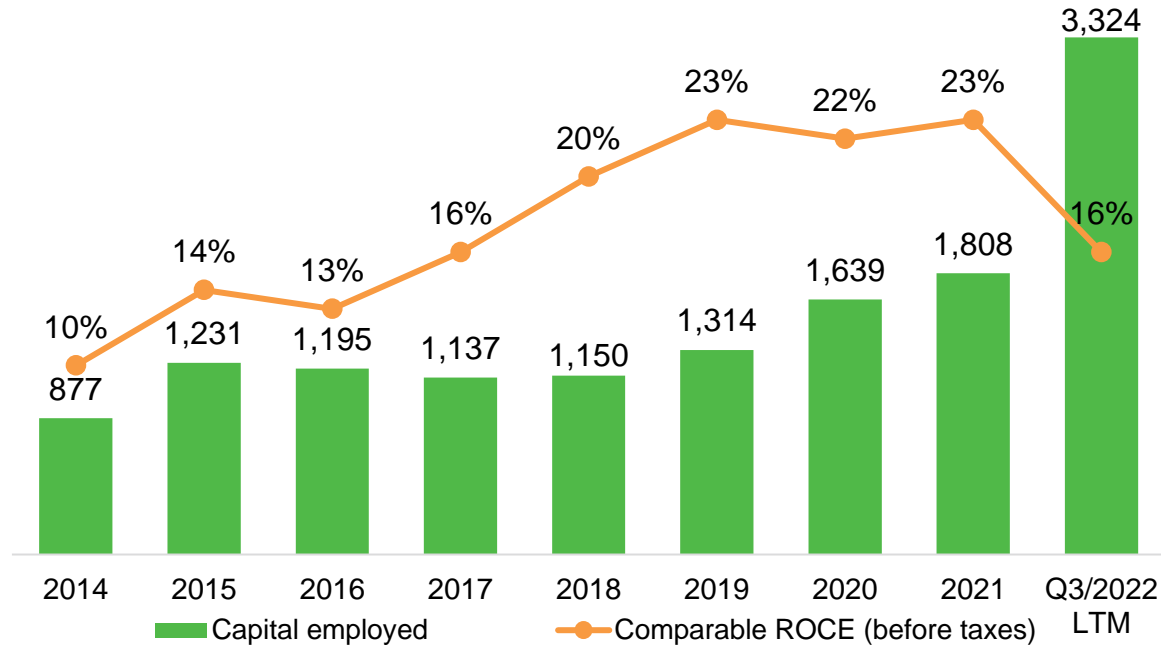

Earnings per share (EPS) and Adjusted EPS, EUR

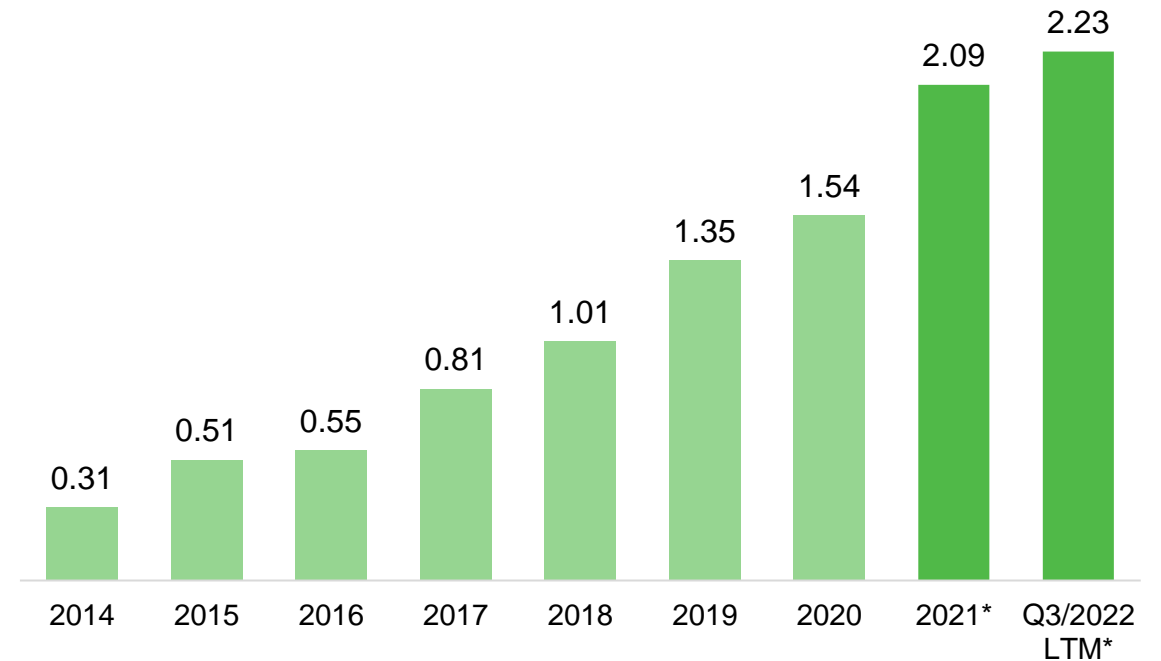

- Comparable ROCE decreased to 16%
- Capital employed was EUR 1,516 million higher than at the end of 2021
 - Total merger consideration for Neles amounted to EUR 1,476 million in Q2/2022

*Adjusted EPS. Adjusted earnings per share is an alternative performance measure that excludes the impact of fair value adjustments arising from business combinations, net of tax

Valmet implemented IFRS 16 – Leases as of January 1, 2019 by applying the simplified transition method, and IFRS 15 – Revenue from Contracts with Customers as of January 1, 2018 by applying full retrospective method. Thus, figures presented are not fully comparable.

Dividend and balance sheet

Dividend payout at least 50% of net profit

Track record

Dividend per share (EUR) and payout ratio (%)

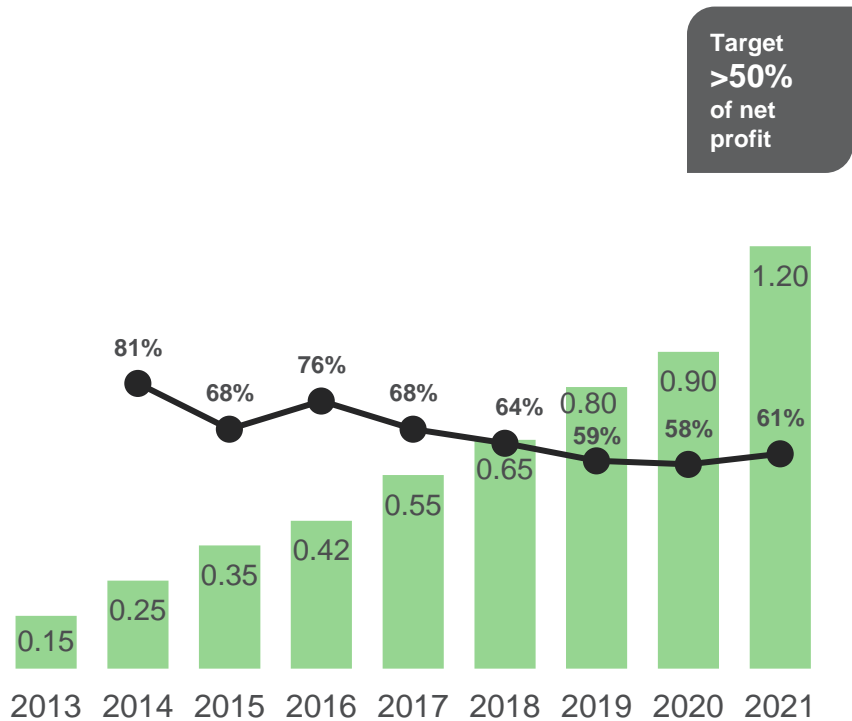

Balance sheet and cash flow

Net debt (EUR million)
Net debt / EBITDA ratio

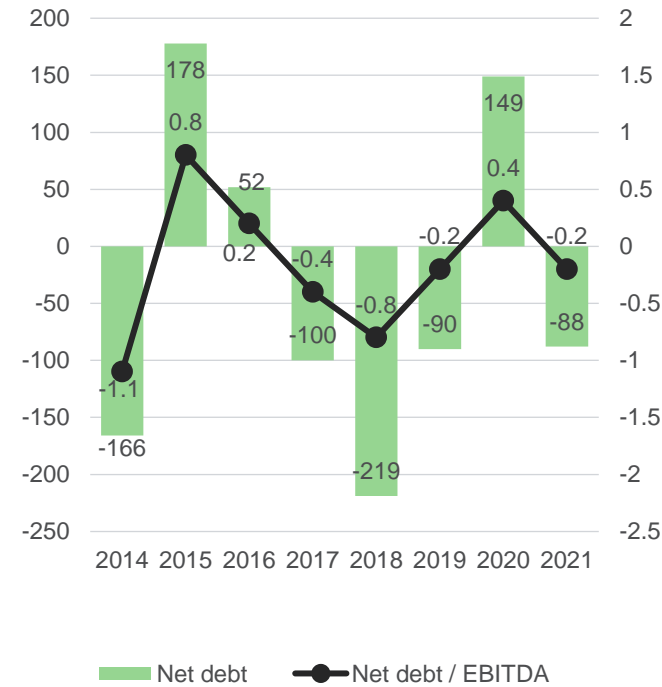

Cash flow provided by operating activities
Net working capital

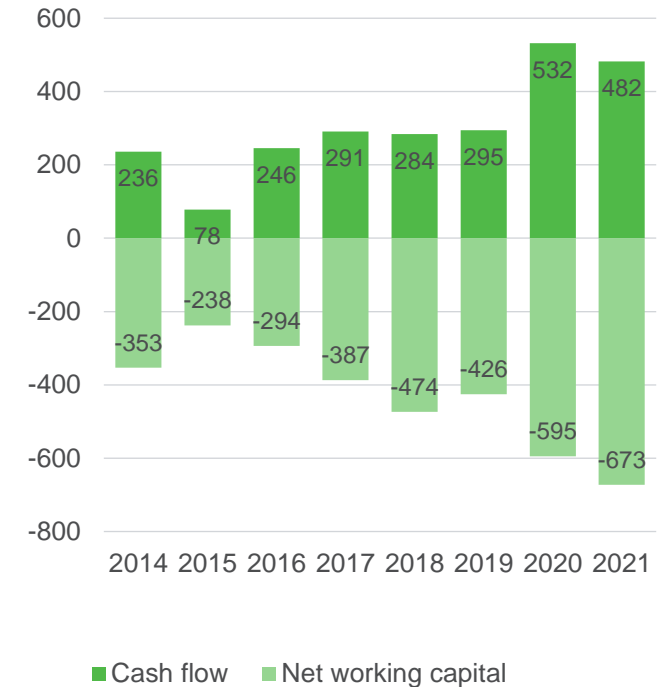

Orders received and profitability development, annual

Orders received (EUR million)¹

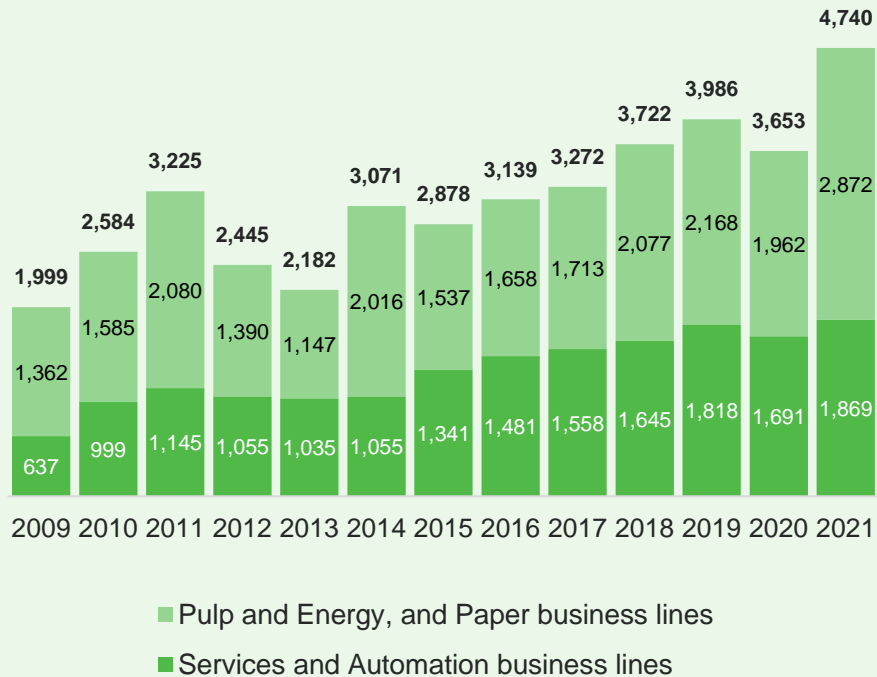

Net sales and Comparable EBITA (EUR million)¹

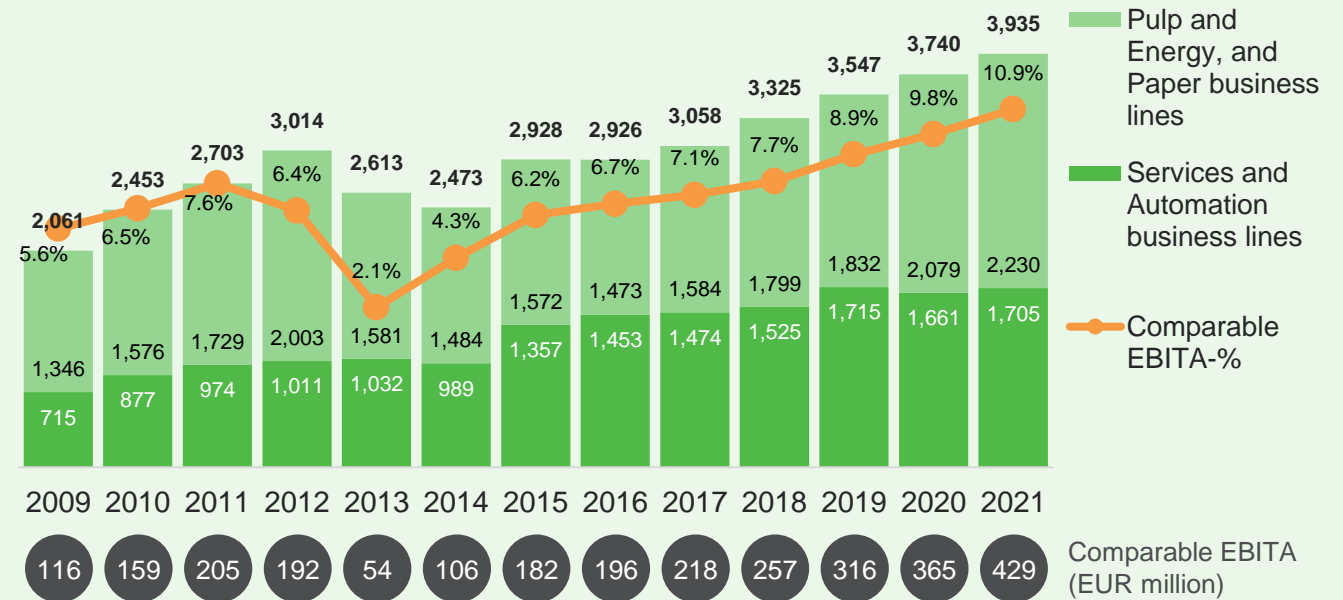

1) Carve-out figures for 2010-2013; as reported for Metso's Pulp, Paper and Power segment for 2006-2009. Automation has been consolidated into Valmet's financials since April 1, 2015, when the acquisition of Automation was completed.



Appendix

Growth and profitability improvement

Actions to keep growing faster than the market

Net sales growth

Stable business

- Win new customers and increase share of wallet with existing customers
- Grow service sales and multi-year service agreements with project sales
- Add customer value with on-site and remote services
- Continue to develop Field services as a differentiator
- Competitor replacements in Automation Systems
- Grow through new industries in Automation Systems
- Leverage the new Valmet DNA User Interface to win new business in Automation Systems
- Continued growth in existing and new industries such as metals & mining and renewable energy in Flow Control
- Growing both organically and through selected acquisitions in Flow Control

Capital business

- Benefit from strong favorable megatrends in Board, Tissue, Pulp and Energy
- Continue to bring advanced technology to the market
- Leverage strong R&D for new product innovations
- Continued focus on product cost competitiveness
- Create customer value with digitalization and Industrial Internet

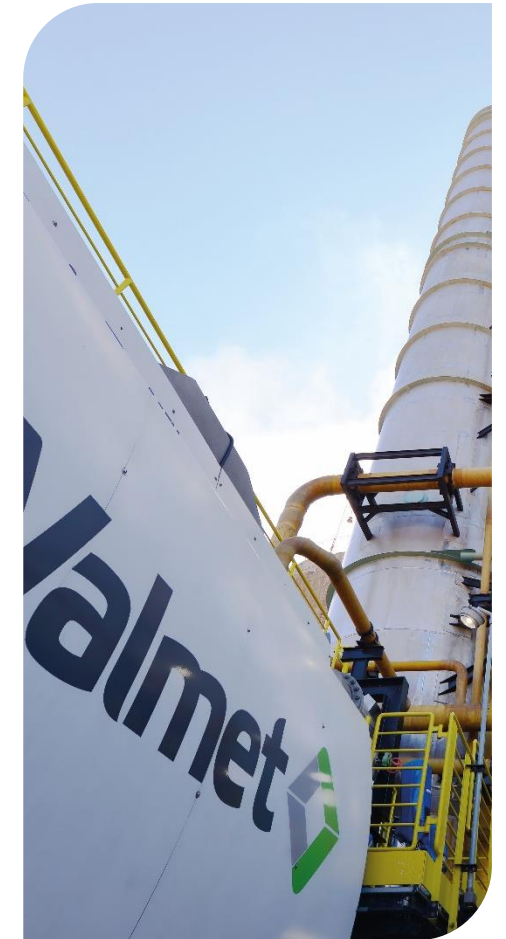

Procurement and quality cost development

Implemented procurement savings of annual direct spend

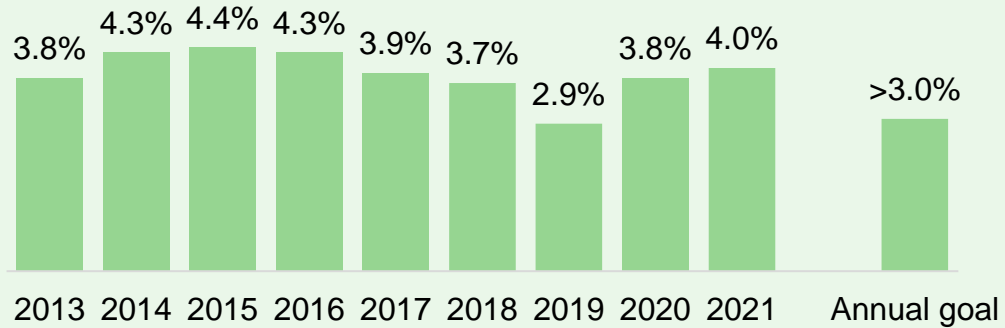

Targeting >3% of procurement savings annually

- Increasing design-to-cost (DTC) to create new sources for savings
- More supplier involvement through supplier relationship management
- Continuing sustainable supply chain implementation

Quality costs (% of net sales)

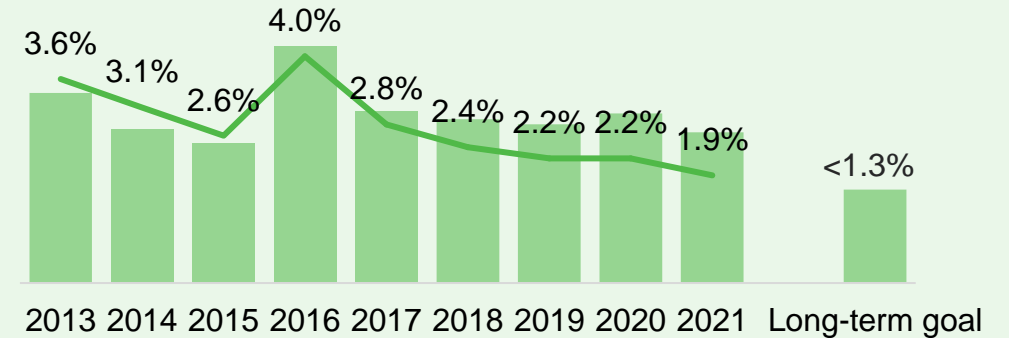

Long-term quality costs goal <1.3% of net sales

- Adding focus on global processes and Global Management System
- Focused quality development projects related to supplier quality, quality assurance and quality control, continuous improvement, audit and risk management

Merger of Valmet and Neles created a leading company with a unique offering for process industries globally

- Merger of Valmet and Neles was registered and the combination of Valmet's and Neles' business operations completed on April 1, 2022
- Valmet acquired 29.5% of Neles shares in 2020 for EUR 456 million, average price per share was EUR 10.27
- Merger consideration to Neles' shareholders was approximately 34.7 million Valmet shares, amounting to EUR 978 million
- The total cost of Neles' shares acquired by Valmet amounted to EUR 1,434 million
- Valmet's share price at the end of March 31, 2022, was EUR 28.21
- Valmet's number of shares increased to approximately 184.5 million
- Neles' extra distribution before the merger to Neles shareholders was EUR 2.00 per share
- Starting from Q2/2022, Neles is part of Valmet's Automation segment and forms the fifth business line to Valmet, called Flow Control

Acquisitions

- Valmet's acquisition strategy is to make selective acquisitions with a clear industrial logic to support organic growth
 - Focus on strengthening services and automation and expanding business in the pulp, paper and energy value chain
- Approximately 50 cases evaluated annually
- Eight acquisitions made since becoming independent company in 2014
- Total investment in acquisitions and in the merger with Neles about EUR 2 billion

Track record of successful acquisitions

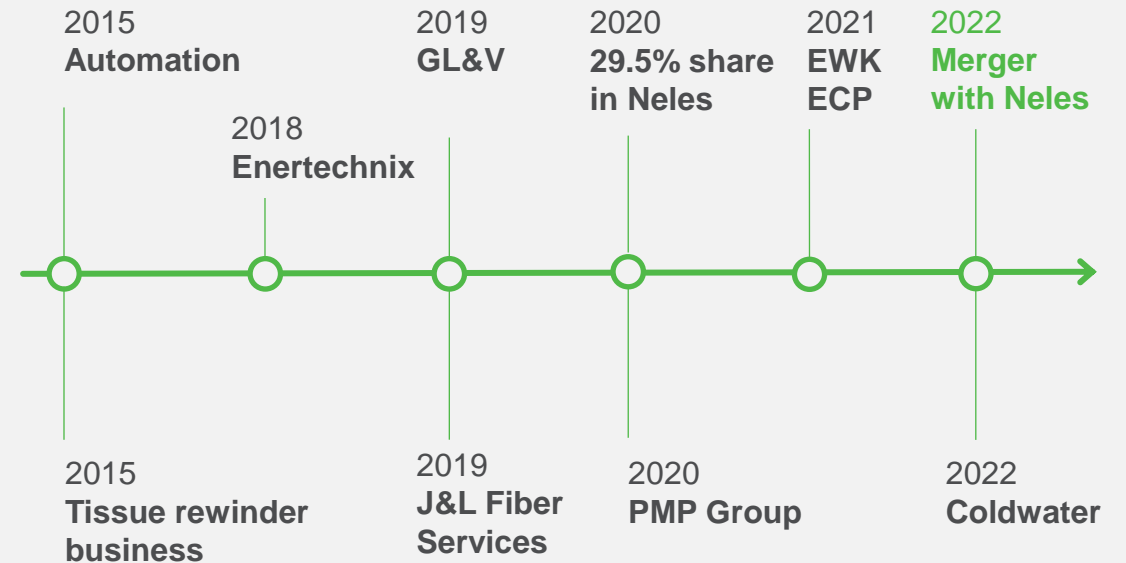

Valmet strengthened its business by acquiring PMP Group in 2020

Focus on small and medium-sized tissue machines and board and paper machine rebuilds

- PMP Group supplies process technologies and services for tissue, board and paper machines globally
 - New tissue machines
 - Rebuilds and machine sections for paper and board machines
 - Spare parts and services
- Focus on small and medium-sized tissue machines and board and paper machine rebuilds
- The acquisition complements Valmet's offering and builds further our local presence especially in Central Europe and China
 - Widens Valmet's portfolio to small and medium-sized tissue machines
 - Access to new customer and product segments
- Operations in four countries: Poland, China, USA and Italy
- The acquisition was announced on September 11, 2020 and was completed on October 1, 2020

Key information about the acquisition

Net sales in 2019	EUR ~70 million
Number of employees	~650
Value of acquisition	EUR ~64 million ¹

1) Plus a conditional and capped earn-out component.

Operations in Poland, China, USA and Italy



Valmet strengthened its stable business through acquisitions

Valmet completed the acquisitions of GL&V and J&L Fiber Services in Q2/2019

- **GL&V** is a supplier of technologies, upgrade and process optimization services, rebuilds and spare parts for the pulp and paper industry globally
 - Focus in chemical pulping, stock preparation, papermaking and finishing
 - Key locations in the US and Canada, operations also in Europe, India and South America
- Majority of the business is reported in the Services business line

- **J&L Fiber Services** is a manufacturer and provider of refiner segments to the pulp, paper and fiberboard industry
 - Most of the employees are located in Wisconsin, U.S, with global operations through a sales representative and distribution network.
- The acquired business became a part of Valmet's Services business line

Key information

Net sales in 2018	EUR ~160 million
EBITA margin in 2018	~11%
Number of employees	~630
Value of acquisition ¹	EUR ~113 million

¹) Value on a cash and debt free basis subject to ordinary post-closing adjustments

Approximate split of net sales

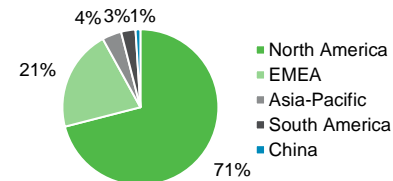



Key information

Net sales in 2018	EUR ~30 million
EBITA margin in 2018	~15%
Number of employees	~100
Value of acquisition ¹	EUR ~51 million

¹) Value on a cash and debt free basis subject to ordinary post-closing adjustments

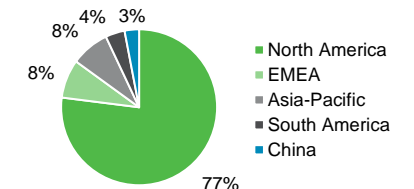
Approximate split of net sales





Appendix
**Shareholders and share price
development**

Largest shareholders on October 31, 2022

Based on indicative data collected by Modular Finance

#	Shareholder name	Number of shares	% of shares and votes
1	Solidium Oy	18,640,665	10.10 %
2	Oras Invest Oy	8,547,691	4.63 %
3	Swedbank Robur Fonder	7,346,111	3.98 %
4	Varma Mutual Pension Insurance Company	6,712,789	3.64 %
5	Ilmarinen Mutual Pension Insurance Company	6,142,993	3.33 %
5	Vanguard	569,0284	3.08 %
7	Cevian Capital	4,408,171	2.39 %
8	BlackRock	4,209,869	2.28 %
9	Norges Bank	3,032,001	2.02 %
10	SEB fonder	3,141,578	1.71 %
	<i>10 largest shareholders, total</i>	<i>67,872,152</i>	<i>37.16 %</i>
	<i>Other shareholders</i>	<i>116,657,453</i>	<i>62.84 %</i>
	Total	184,529,605	100.0%

Five latest flagging notifications

Date of transaction	Shareholder	Number of shares	% of shares and votes
Aug 28, 2019	BlackRock, Inc.	Below 5%	Below 5%
Aug 29, 2019	BlackRock, Inc.	7,740,836	5.16%
Aug 30, 2019	BlackRock, Inc.	Below 5%	Below 5%
Apr 1, 2022	Solidium Oy	17,072,199	9.25%
May 19, 2022	Solidium Oy	18,640,665	10.10%

1) Solidium is a holding company that is wholly owned by the Finnish State



Shareholder structure on October 31, 2022

Based on Euroclear data. The classification of sectors determined by Statistics Finland.

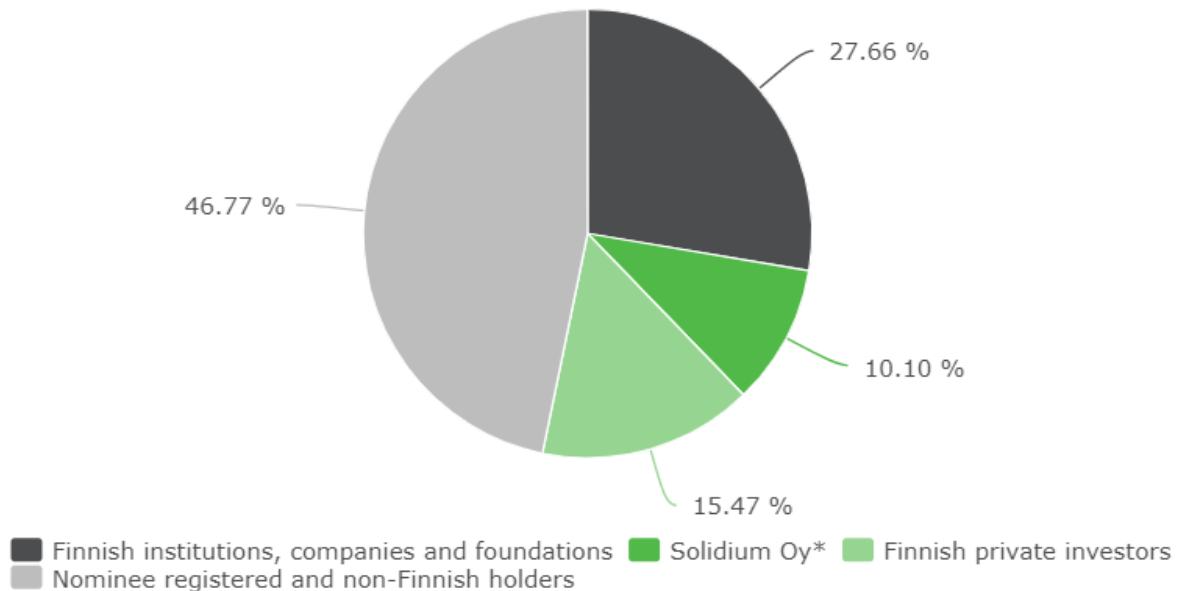

Sector	Number of shareholders	% of total shareholders	Number of shares	% of shares
Nominee registered and non-Finnish holders	467	0.55	86,300,076	46.77
Finnish institutions, companies and foundations	4,069	4.79	51,030,877	27.65
Solidium Oy*	0	0.00	18,640,665	10.10
Finnish private investors	80,492	94.67	28,547,392	15.47
On issuer account	0	0.00	10,595	0.01
Total	85,028	100.00	184,529,605	100.00

* Solidium is a holding company that is wholly owned by the Finnish State

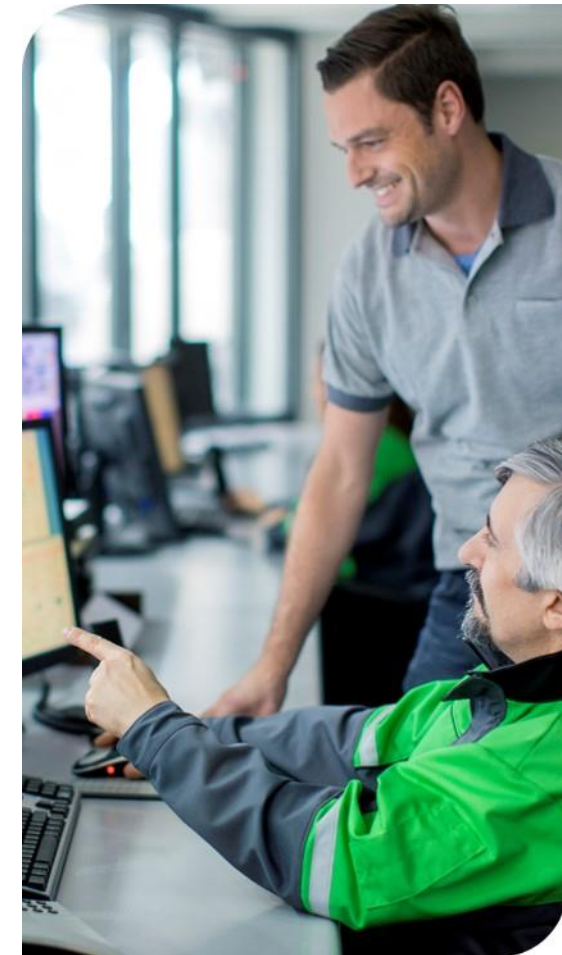

Share of non-Finnish holders and number of shareholders

Valmet has 85,028 shareholders and 46.8% of the shares are held by investors outside Finland

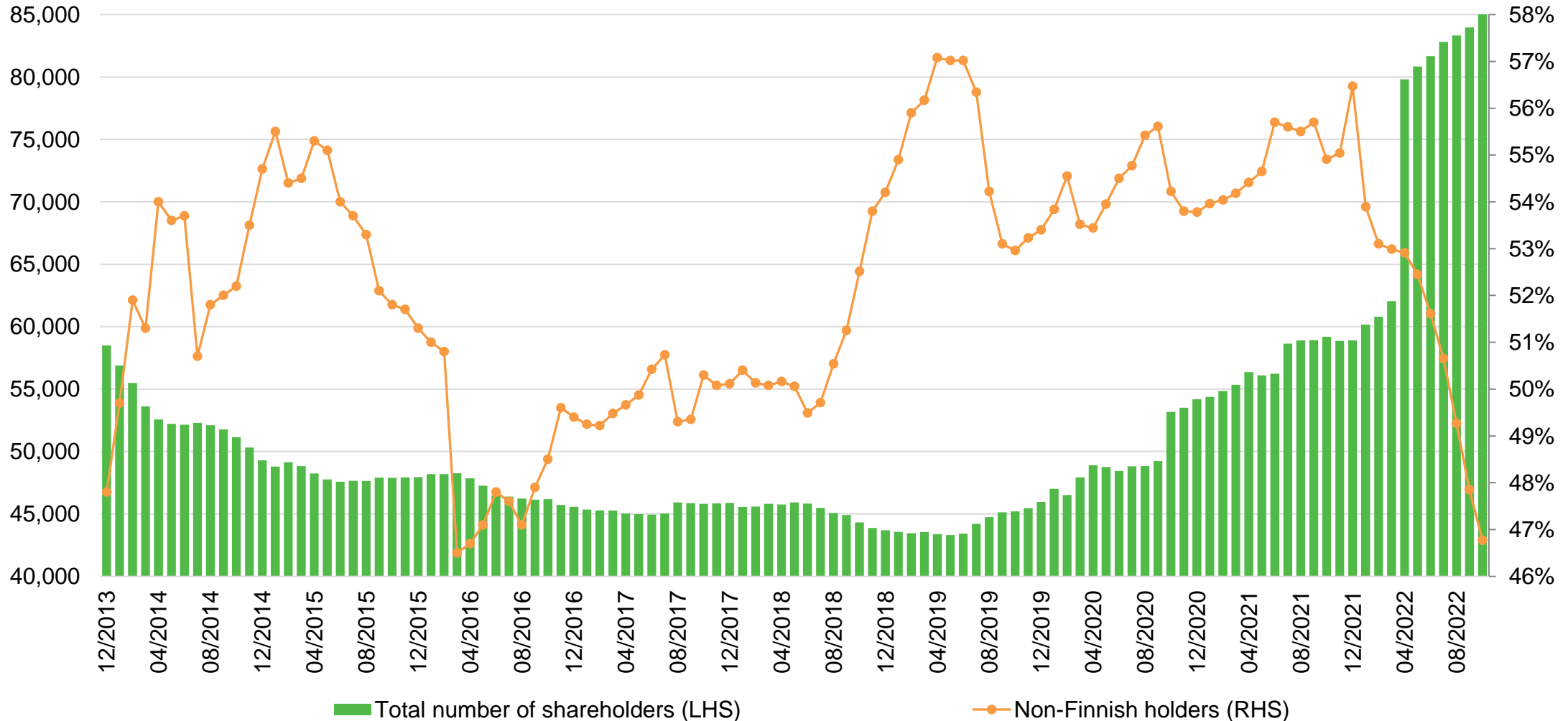

Valmet share price development

Valmet share price development vs OMXH price index, last 3 years

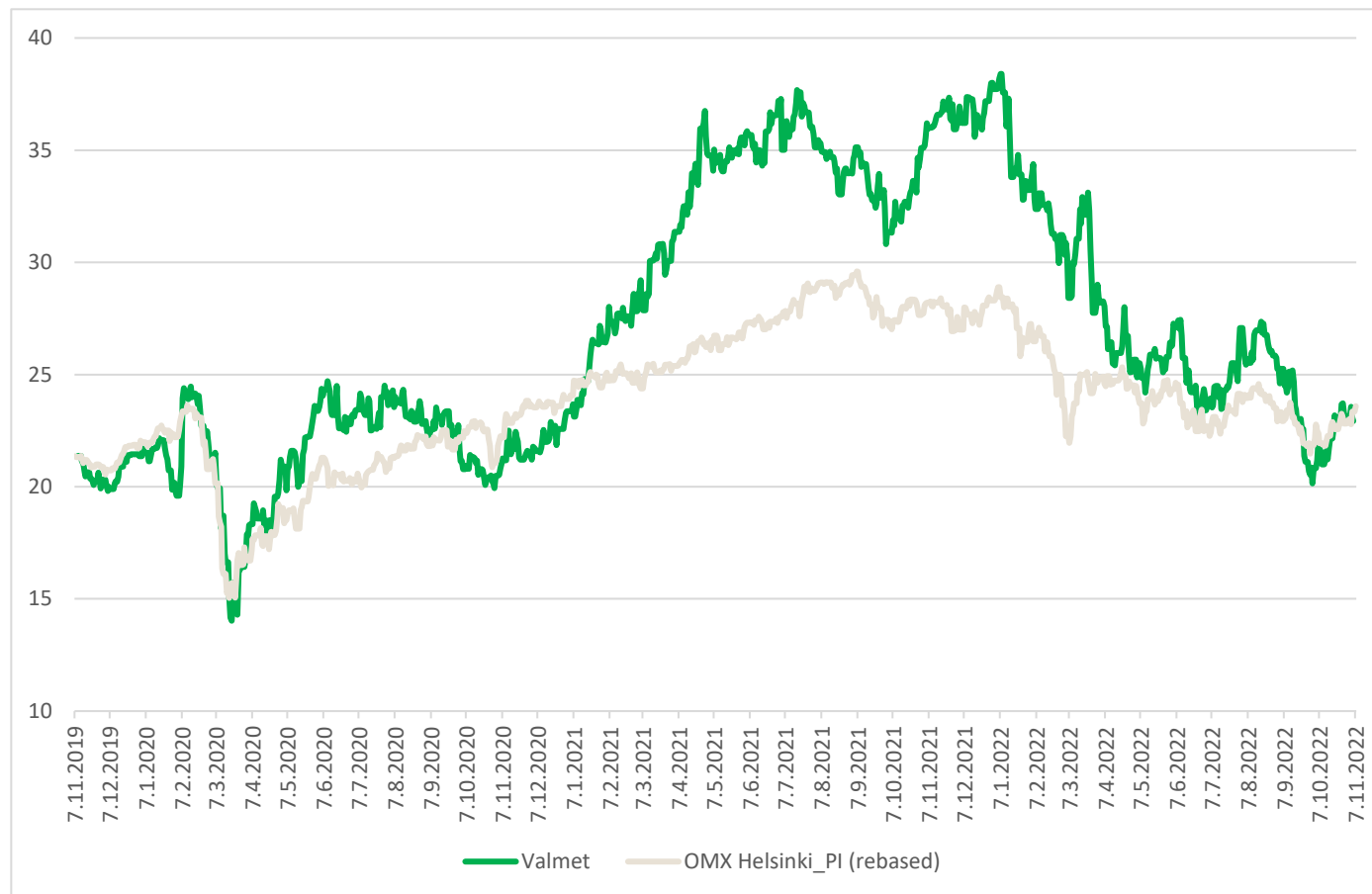

Share price YTD 2022	Valmet	OMX Helsinki
December 31, 2021	37.72	12,862
October 31, 2022	23.03	10,396
High	38.41	13,132
Low	20.14	9,757
Market cap (EUR million)	4,250	

	Volume 2022	% of outstanding
Total	111,937,320	60.8 %
Median	472,457	0.3 %
Average	530,509	0.3 %
Max	4,062,755	2.2 %
Min	161,391	0.1 %
No. of shares outstanding	184,187,034	

Source: Infront



Appendix
Strategy and offering

Valmet's Way Forward

Mission

Converting renewable resources into sustainable results

Strategy

Valmet develops and supplies competitive and reliable process technologies, services and automation to the pulp, paper and energy industries.

Our automation business covers a wide base of global process industries.

We are committed to moving our customers' performance forward with our unique offering and way to serve.

Continuous improvement and renewal

Must-Wins

- Customer excellence
- Leader in technology and innovation
- Excellence in processes
- Winning team

Business accelerators

Vision

To become the global champion in serving our customers and in moving the industries forward

Our Values



Customers

We move our customers' performance forward



Renewal

We promote new ideas to create the future



Excellence

We improve every day to deliver results



People

We work together to make a difference

Megatrends

- Resource efficient and clean world
- Digitalization and new technologies
- Urban, responsible and global consumer

Services segment



Performance Parts

Spare parts and consumables



Rolls and Workshop Services

Rolls, roll covers and maintenance, workshop services



Fabrics

Paper machine clothing and filter fabrics



Board, Paper and Tissue Solutions

Improvement Projects, Field Services, Life Cycle Agreements, Outsourcing

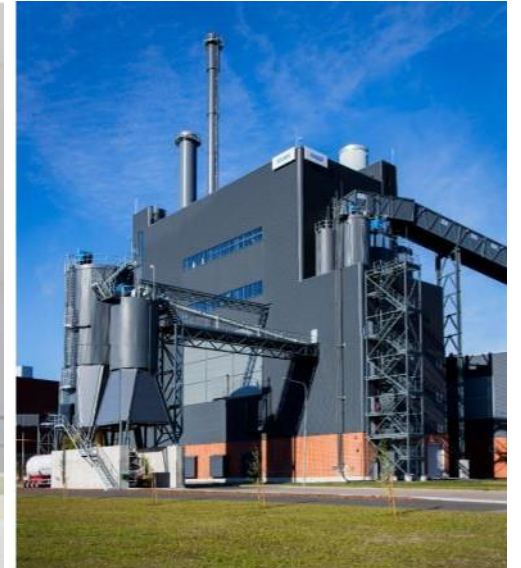

Pulp and Energy Solutions

Improvement Projects, Field Services, Life Cycle Agreements, Outsourcing

Our way to serve - Right combination of services for every stage in the lifecycle

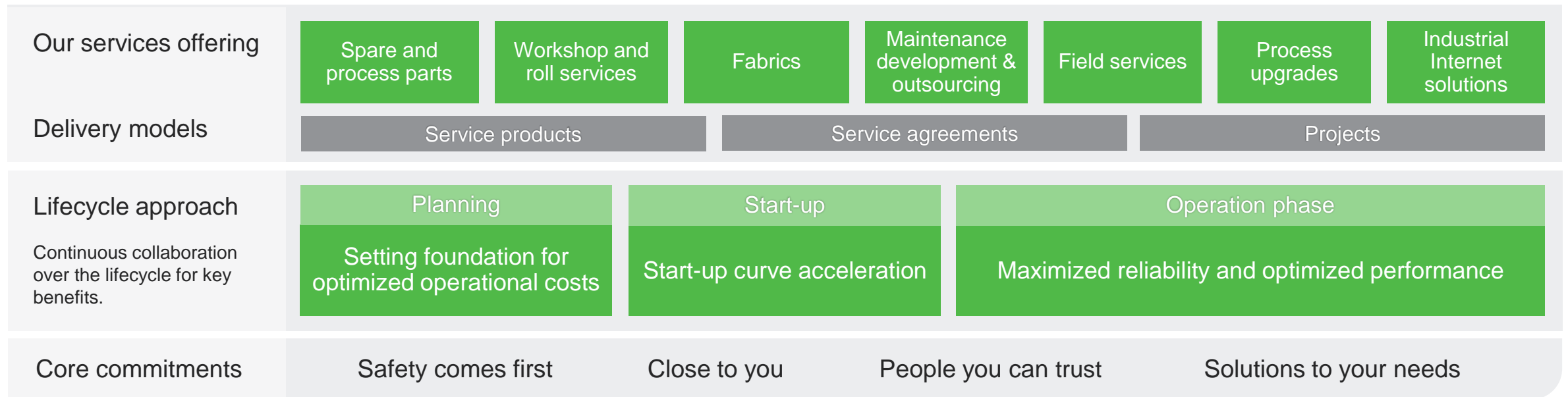

Flow Control business line offering



- Control valves
- Automated on/off valves
- Emergency shut-down valves



High-performing pneumatic, electric and manual actuators designed to maximize cycle life and improve process efficiency



Automatic valve controllers and valve positioners to improve process efficiency and enable predictive valve maintenance

Automation Systems business line offering

Delivered as products and technology, projects and service agreements



- Highly integrated automation system for process control and condition monitoring.



- Quality control system, quality management applications.

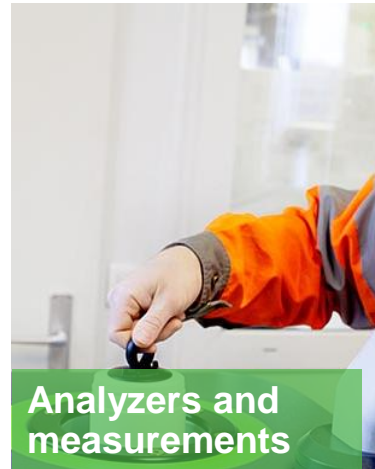

- For measuring and optimizing different variables in industrial processes.



- Advanced controls and data-driven applications for assisted decision making and mill-wide optimization.
- Remote expert support from Valmet Performance Center.
- Valmet Customer portal for relevant information and collaboration.



- Services for high availability, intelligent maintenance, process performance and risk control.

Future-proof automation solutions and services

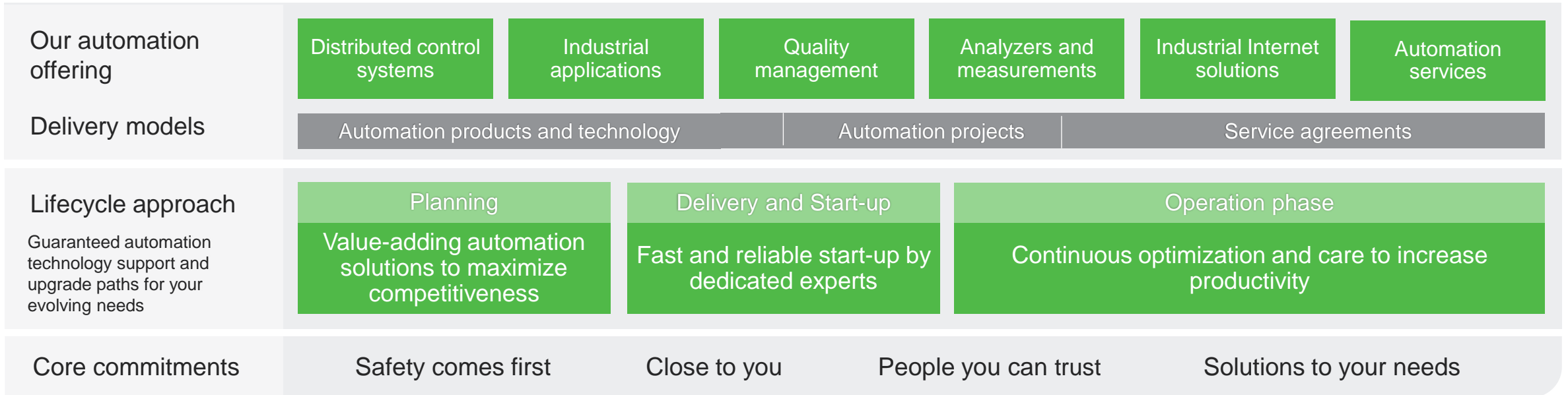



Automation Systems business line offering and market overview

Advanced automation and process monitoring solutions and services:

- Distributed Control System (DCS) – Valmet DNA
- Performance solutions
- Quality Control System (QCS)
- Profilers
- Analyzers and measurements
- Industrial internet solutions
- Automation services
- Process simulators
- Safety systems and solutions

Over 4,500 automation systems and over 40,000 analyzers and measurements delivered

	Scope/product	Market size	Main competitors
Distributed Control System (DCS)  #3	<ul style="list-style-type: none"> • DCS for process and plant controls • Condition monitoring • Information management • APC (advanced process control) • Industrial Internet applications 	Pulp and paper DCS market: <ul style="list-style-type: none"> • EUR 900 million Power DCS market: <ul style="list-style-type: none"> • EUR 700 million 	<ul style="list-style-type: none"> • ABB • Honeywell • Emerson • Siemens • Yokogawa
Quality Management System  #1-2	<ul style="list-style-type: none"> • QCS (Quality Control Systems) • Profilers • Web inspection and web break analysis systems 	Estimated market size: <ul style="list-style-type: none"> • >EUR 200 million 	<ul style="list-style-type: none"> • ABB • Honeywell • Voith • Paperchine • Procemex • Cognex • Isra Vision
Analyzers and measurements  #1	<ul style="list-style-type: none"> • Paper analyzers • Pulp analyzers • Pulp consistency measurements • Conductivity measurements • Power analyzers 	Estimated market size: <ul style="list-style-type: none"> • <EUR 200 million 	<ul style="list-style-type: none"> • ABB • BTG



Pulp and Energy business line offering

Leading global technology supplier



Pulp

- Chemical pulp mill
 - Wood handling
 - Cooking and fiber line
 - Pulp drying and baling
 - Chemical recovery
- Mechanical pulping
- Fiberboard defibrator systems
- Industrial Internet and remote support

Biomass conversion

- Pretreatment for bioethanol production
- Black pellets
- Lignin extraction



Energy

- Technology for biomass and municipal and industrial residual waste
- Fluidized bed boilers
 - Modular power plants
 - Gasification
 - Pyrolysis process
 - Industrial Internet and remote support

Emission control

- Power plant flue gas cleaning
- Flue gas heat recovery
- NO_x control
- Marine scrubbers

Paper business line offering



- **Stock preparation lines**

- Recycled fiber lines
- Stock preparation systems
- Approach flow systems
- Broke collection and handling

- **Rebuilds**

- Modernization and upgrades for performance improvements

- **Stand-alone products**

- E.g., refiners, screens, pulpers

- **Board and paper production lines**

- Technologies for all board and paper grades
- Technologies for all size of machinery
- Tailor-made board and paper machines
- Modularized board and paper machines

- **Rebuilds**

- Modernizations and grade conversions

- **Stand-alone products**

- E.g., headboxes, sizers, winders

- **Tissue production lines**

- Technologies for all tissue grades and products
- Technologies for all size of machinery
- Conventional, textured and structured tissue production

- **Rebuilds**

- Upgrades for energy, product quality, safety and efficiency improvements

- **Stand-alone products**

- E.g., headboxes, Yankee cylinders, rewinders

Full scope offering for the pulp and paper industry

Technologies

- 1 Wood handling
- 2 Heat and power production
- 3 Chemical pulping
- 4 Chemical recovery
- 5 Pulp drying
- 6 Recycled fiber
- 7 Mechanical fiber
- 8 Stock preparation
- 9 Board and paper making
- 10 Tissue making

Automation

- Distributed Control System (DCS)
- Performance solutions
- Quality Control System (QCS)
- Profilers
- Analyzers and measurements
- Industrial internet solutions
- Automation services
- Process simulators
- Safety systems and solutions

Services

- Mill and plant improvements
- Spare and wear parts
- Paper machine clothing and filter fabrics
- Roll services
- Services for evaporation plants, power and recovery boilers
- Services for environmental equipment

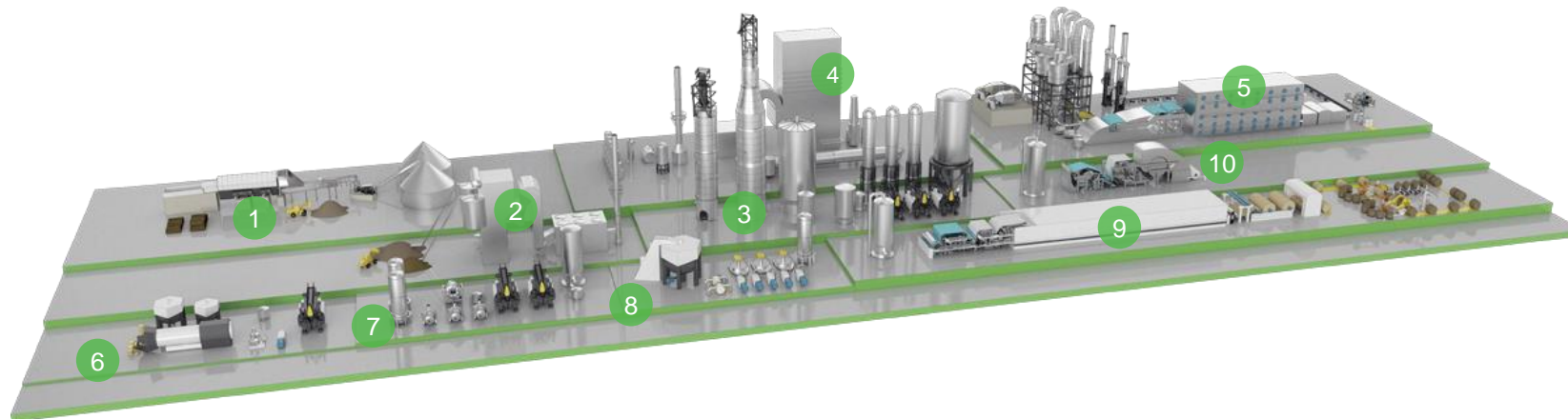

Our offering for energy industry and biotechnologies

Technologies

- 1 Fuel handling
- 2 Gasification
- 3 Boiler and flue gas cleaning
- 4 Bio-oil production
- 5 Modularized power plants
- 6 Prehydrolysis
For biofuels, biomaterials and biochemicals, and bio coal production

Automation

- Distributed Control System (DCS)
- Performance solutions
- Analyzers and measurements
- Industrial internet solutions
- Automation services

Services

- Plant improvements
- Rebuilds
- Performance services
- Services for environmental equipment
- Components and spare parts
- Training

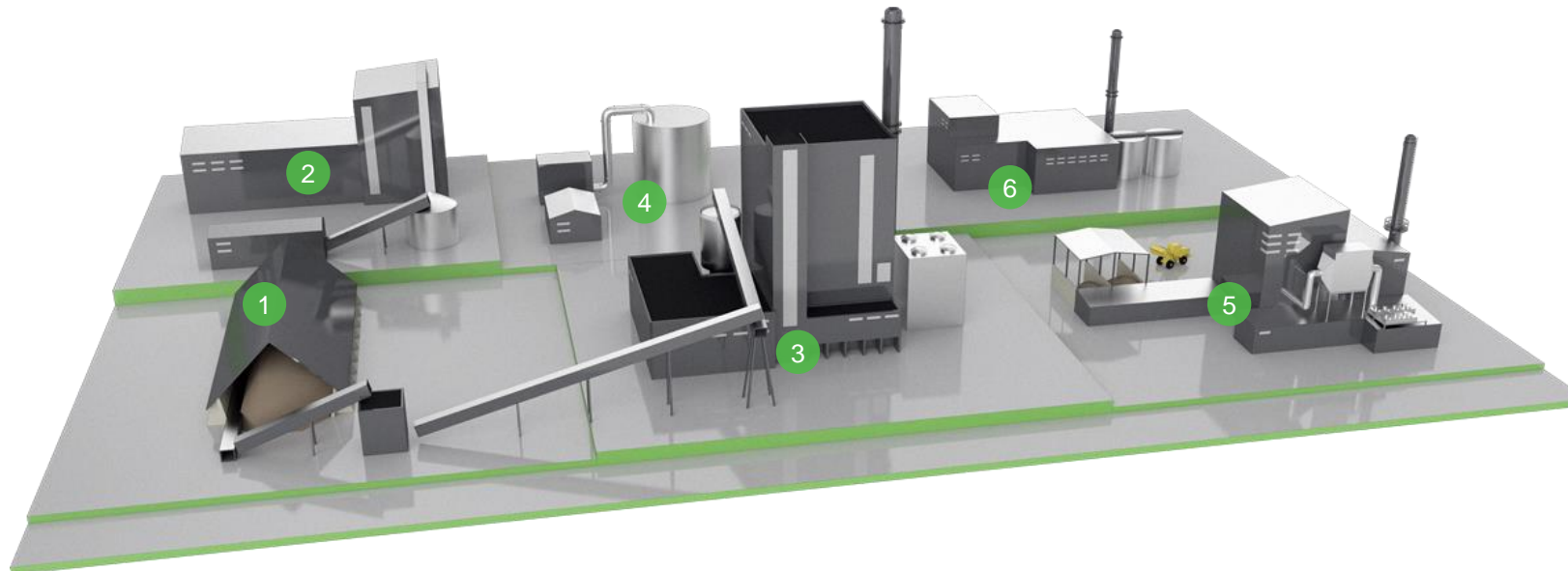

Continuous investment in research and development to improve customers' processes



Customers' needs

- Increase production efficiency
- Improve competitiveness
- Maximize value of raw materials
- Widen raw material base
- Provide high-value end products
- Develop new innovations and technologies



Valmet's R&D focus

- Modularized and standardized products
- Energy, water and raw material efficiency
- Automation technology
- Biomass conversion technologies

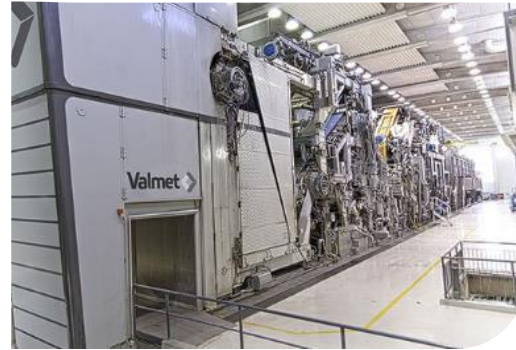

Valmet's R&D resources

- Own R&D centers and pilot facilities
- Annual R&D spend EUR 98 million (2021)
- Around 1,300 protected inventions
- Cooperation with universities and research institutions



Example of our R&D work – OptiConcept M board and paper machine

- Cost-efficient, high-quality, safe and flexible board making concept
- Significant savings in energy, water and raw material use
 - Energy efficiency improvement up to 30%
- Modular and compact size
 - Short delivery times, quick start-ups, and less production space
- Functional design brings increased safety and accessibility

Business accelerator: Valmet Industrial Internet - VII

Dialogue with data to move our customers performance forward

Recent development

- VII solutions in place for all customer segments
- Development of Mill Wide Optimization application
- Asset Performance Manager for installed base monitoring and fleet management

Next steps and development actions

- Augment competence of people in control room through VII applications and Valmet DNA user interface
- Move towards more autonomous mills leveraging automation and process technology

Valmet Performance Center delivering remote support



2,900

Remote support cases solved in 2021

130

Customers connected to Valmet cloud

710

Remote connections

390

Advanced Process Controls

Typical dimensions of pulp mills, and paper, board and tissue machines

Pulp mill

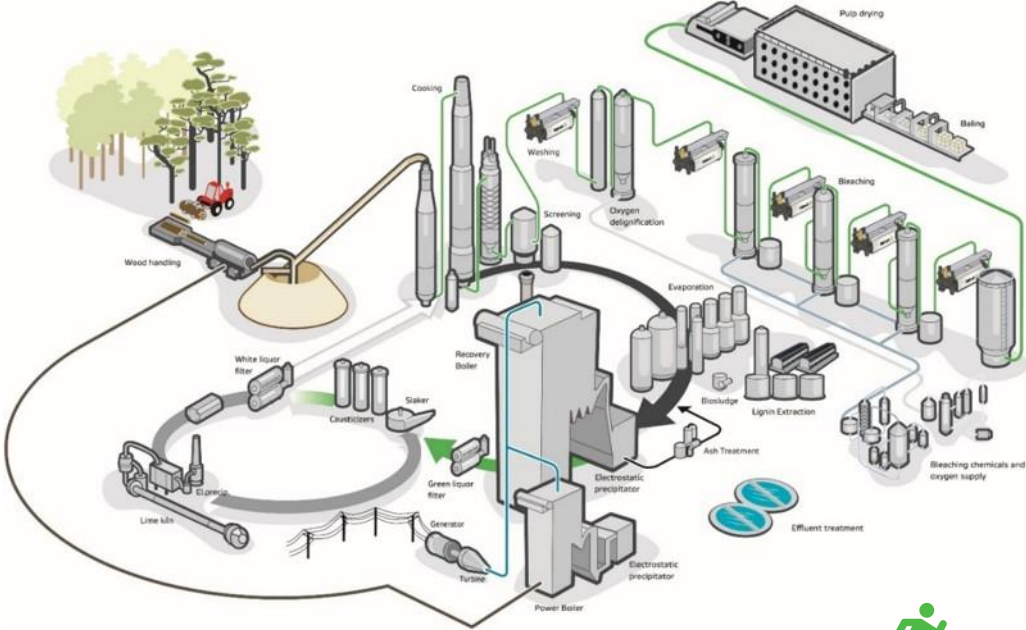

- Mill site area: 500,000 – 5,000,000 m², equivalent to **~70–700** football fields 
- Built area: 40,000 – 100,000 m², equivalent to **~6–14** football fields

Paper and board machine

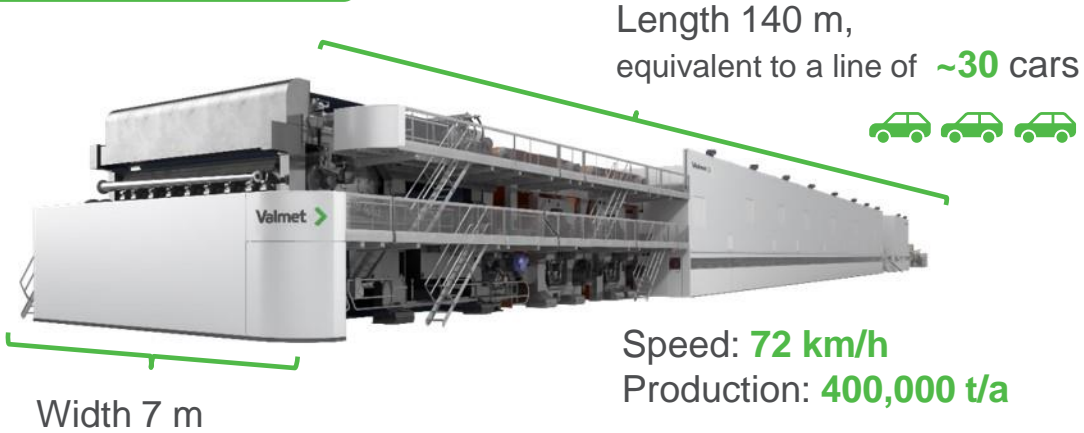

Tissue machine

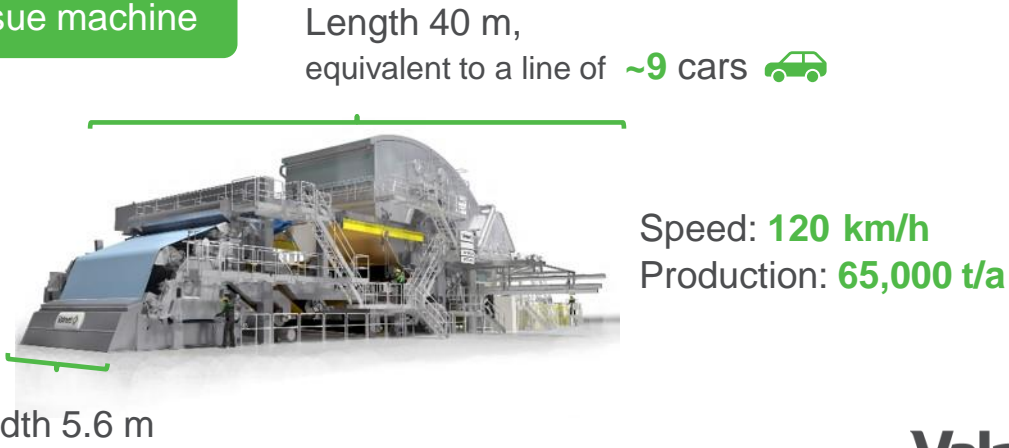



Appendix
Management and remuneration

Board of Directors



Mikael Mäkinen
(b. 1956)
Chairman of
the Board
Finnish citizen

- M.Sc. (Eng.)
- Other positions of trust:
 - Chairman of the Board of AkerArctic Technology Inc. and Corvus Energy
 - Board member in SSAB and Finlines Oyj
- Share ownership: 7,462
- Independent of company: Yes
- Independent of owners: Yes



Jaakko Eskola
(b. 1958)
Vice-Chairman of
the Board
Finnish citizen

- M.Sc. (Eng.)
- Other positions of trust:
 - Chairman of the Board of Enersense International Oyj, Varma Mutual Pension Insurance Company, Suominen Oyj and Cargotec Oyj
- Share ownership: 2,423
- Independent of company: Yes
- Independent of owners: Yes



Aaro Cantell
(b. 1964)
Vice-Chairman of
the Board
Finnish citizen

- M.Sc. (Tech.)
- Other positions of trust:
 - Chairman of the Board of Normet Group Oy and Technology Industry Employers of Finland
 - Vice-Chairman of the Board of Solidium Oy
- Share ownership: 8,408
- Independent of company: Yes
- Independent of owners: No



Anu Hämäläinen
(b. 1965)
Board member
Finnish citizen

- M.Sc. (Econ.)
- VP, Group Treasury and Financial Services at Kesko
- Other positions of trust:
 - Board member of Finnish Fund for Industrial Cooperation Ltd. and Vähittäiskaupan Tilipalvelu VTP Oy
- Share ownership: 2,239
- Independent of company: Yes
- Independent of owners: Yes



Pekka Kemppainen
(b. 1954)
Board member
Finnish citizen

- Lic.Sc. (Tech.)
- Other positions of trust:
 - Chairman of the Board of Nestor Cables Oy
 - Board member in Bittium Oyj and Junttan Oy
- Share ownership: 4,578
- Independent of company: Yes
- Independent of owners: Yes



Per Lindberg
(b. 1959)
Board member
Swedish citizen

- M.Sc. Mechanical Engineering
- PhD, Industrial Management and Economics
- Other positions of trust:
 - Chairman of the BoD of Permascand AB and Nordic Brass Gusum AB
 - Board member in Boliden AB
- Share ownership: 1,634
- Independent of company: Yes
- Independent of owners: Yes



Monika Maurer
(b. 1956)
Board member
German citizen

- Diploma in Physics and Chemistry
- Diploma in Pedagogy
- CEO of Radio Frequency Systems
- Other positions of trust:
 - Vice Chairman of the Board in Nokia Shanghai Bell, Co. Ltd
- Share ownership: 4,578
- Independent of company: Yes
- Independent of owners: Yes



Eriikka Söderström
(b. 1968)
Board member
Finnish citizen

- M.Sc. (Econ.)
- Other positions of trust:
 - Board member of Bekaert, Kempower Oyj and Amadeus IT Group
- Share ownership: 5,708
- Independent of company: Yes
- Independent of owners: Yes

Executive Team

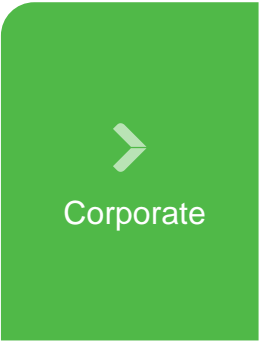

Pasi Laine
President and CEO
Share ownership: 177,137



Katri Hokkanen
CFO
Share ownership: 5,598



Julia Macharey
SVP, Human Resources and
Operational Development
Share ownership: 38,319



Anu Salonsaari-Posti
SVP, Marketing, Communications,
Sustainability and Corporate Relations
Share ownership: 31,350



Aki Niemi
Business Line President,
Services
Share ownership: 63,222



Emilia Torttila-Miettinen
Business Line President,
Automation as of Dec 1, 2022



Simo Sääskilahti
Business Line President,
Flow Control
Share ownership: 1,437



Sami Riekkola
Business Line President,
Pulp and Energy
Share ownership: 16,433



Jari Vähäpesola
Business Line President,
Paper
Share ownership: 61,348



Jukka Tiitinen
Area President,
North America
Share ownership: 94,330



Celso Tacla
Area President,
South America
Share ownership: 94,129



Vesa Simola
Area President,
EMEA
Share ownership: 52,971



Xiangdong Zhu
Area President,
China
Share ownership: 30,617



Petri Paukkunen
Area President,
Asia Pacific
Share ownership: 8,418

Remuneration of the President and CEO

- The remuneration of the President and CEO is comprised of
 - fixed base salary (incl. taxable benefits¹)
 - short-term and long-term incentives, and
 - pension and insurance benefits
- The relative proportion of the variable pay elements at maximum level is 2–3 times the fixed pay
- The President and CEO is recommended to own and hold Company shares equaling to the CEO's gross annual base salary (100 percent ownership recommendation)
- The notice period for the President and CEO is six months for both parties
- Severance pay (if the company terminates the agreement) equals to six months' notice period plus severance pay corresponding to the last total monthly salary multiplied by 18
- In 2021, the President and CEO's monthly fixed compensation was EUR 55,326 and the fixed annual salary EUR 697,106 (incl. taxable benefits¹)

- More information can be found in Valmet's Remuneration policy and Remuneration report available at [valmet.com](https://www.valmet.com)

1) A company car and phone allowance.

Remuneration of the Executive Team

- The remuneration of the Executive Team members comprises
 - fixed base salary (incl. monthly salary and taxable benefits¹)
 - short-term and long-term incentives, and
 - a supplementary pension plan
- Additional pension benefit in the form of a defined contribution pension plan equaling 15–20% of base salary depending on role
- Notice period is six months for both parties. If the company terminates the agreement, there is an additional severance pay equaling six times the last total monthly salary

¹) Such as a company car and a phone allowance, according to the local legislation and market practice.

The Performance Share Plan for Executive Team members

- Includes a three-year performance period parallel to a one-year performance period
- One-year performance measures are based on long-term strategic and financial targets. They are measured independently and have remained the same for the past eight years.
- One-year performance period followed by a two-year restriction period, vesting after three years
- Includes a recommendation for the members of Valmet’s Executive Team to own and hold an amount of Company shares equaling their gross annual base salary (100% ownership recommendation)

	Long-term incentive plans 2021–2023		Long-term incentive plans 2022–2024	
Plan name	Performance Share Plan and Deferred Share Plan	Performance Share Plan	Performance Share Plan and Deferred Share Plan	Performance Share Plan
Performance period	2021	2021–2023	2022	2022–2024
Incentive based on	Comparable EBITA as a percentage of net sales, and orders received growth in the stable business	Predefined strategic target	Comparable EBITA as a percentage of net sales, and orders received growth in the stable business	ESG Index, targets linked to implementing Valmet’s Climate Program and Sustainability Agenda
Reward payment	In spring 2022	In spring 2024	In spring 2023	In spring 2025

